

# Welch Allyn Spot Vital Signs LXi

---

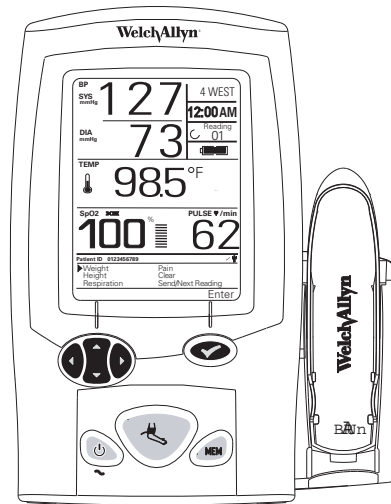
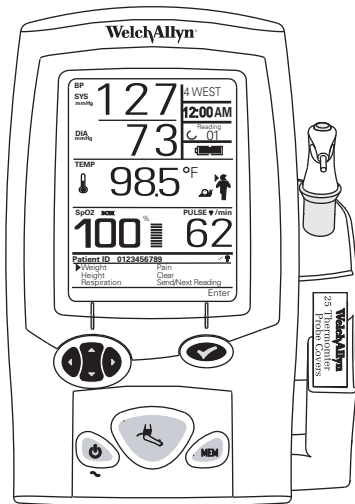

---

## Service Manual

**WelchAllyn®**

Advancing Frontline Care™



# Welch Allyn Spot Vital Signs LXi

---

---

## Service Manual

**WelchAllyn**<sup>®</sup>

Advancing Frontline Care™

Copyright 2008 Welch Allyn. All rights are reserved. No one is permitted to reproduce or duplicate, in any form, this manual or any part thereof without permission from Welch Allyn.

Welch Allyn assumes no responsibility for any injury to anyone, or for any illegal or improper use of the product, that may result from failure to use this product in accordance with the instructions, cautions, warnings, or statement of intended use published in this manual.

Welch Allyn®, Spot Vital Signs®, SureBP® Technology, and SureTemp® are registered trademarks of Welch Allyn.

Braun ThermoScan® is a registered trademark of the Braun Company.

LNCS™ is a trademark of, and SET®, LNOP®, and Masimo® are registered trademarks of, Masimo Corporation. Possession or purchase of a Masimo SpO<sub>2</sub>-equipped device does not convey any express or implied license to use the device with unauthorized sensors or cables which would, alone or in combination with this device, fall within the scope of one or more of the patents relating to this device.

Nellcor® and *Oxi-Max*® are registered trademarks of Nellcor Puritan Bennett Inc.

Software in this product is Copyright 2008 Welch Allyn or its vendors. All rights are reserved. The software is protected by United States of America copyright laws and international treaty provisions applicable worldwide. Under such laws, the licensee is entitled to use the copy of the software incorporated with this instrument as intended in the operation of the product in which it is embedded. The software may not be copied, decompiled, reverse-engineered, disassembled, or otherwise reduced to human-perceivable form. This is not a sale of the software or any copy of the software; all right, title, and ownership of the software remain with Welch Allyn or its vendors.

For information about any Welch Allyn product, call Welch Allyn Technical Support:

USA	+1 800 535 6663 + 1 315 685 4560	Australia	+61 2 9638 3000
Canada	+1 800 561 8797	China	+86 21 6327 9631
European Call Center	+353 46 90 67790	France	+ 331 6009 3366
Germany	+49 7477 9271 70	Japan	+81 3 3219 0071
Latin America	+1 305 669 9003	Netherlands	+31 157 505 000
Singapore	+65 6419 8100	South Africa	+27 11 777 7555
United Kingdom	+44 207 365 6780	Sweden	+46 85 853 6551

## Reorder #4500-89

Manual Material No. 704432 Ver. D

Welch Allyn  
4341 State Street Road  
Skaneateles Falls, NY  
13153 USA



European Regulatory Manager  
Welch Allyn Ltd.  
Navan Business Park  
Dublin Road  
Navan, County Meath, Republic of Ireland  
Tel.: +353 46 90 67700  
Fax: +353 46 90 67755

Printed in USA

CE 0297

**WelchAllyn®**

Advancing Frontline Care™

# Contents

<b>1 - Safety Summary</b> .....	<b>1</b>
Introduction .....	1
Warnings and Cautions .....	1
Electrostatic Discharge (ESD) .....	8
Symbols .....	9
<b>2 - Overview</b> .....	<b>11</b>
Purpose and Scope .....	11
Other Applicable Documents .....	11
Miscellaneous Mounting Accessories .....	12
Mobile Stand Kit .....	14
Radio Mounting Accessory .....	16
Barcode Reader Mounting Accessory .....	17
Warranty .....	18
Service .....	19
Spot Vital Signs LXi Configurations .....	20
Controls .....	20
Display Window .....	22
Connections .....	24
<b>3 - Functional Overview</b> .....	<b>29</b>
Self Test .....	29
Internal Configuration Mode .....	30
<b>4 - Spot Vital Signs LXi Technical Overview</b> .....	<b>35</b>
System Description .....	35
SpO <sub>2</sub> Description .....	37
Radio Description .....	38
Bar Code Scanner Description .....	38
Printer Description .....	40
Interconnect Diagram .....	42
<b>5 - Maintenance and Service</b> .....	<b>43</b>
Cleaning .....	43
Battery Replacement .....	46
Spot Vital Signs LXi Firmware Upgrade CD .....	48
Spot Vital Signs LXi Radio Configuration CD .....	48
Product Disposal .....	48
<b>6 - Calibration and Verification</b> .....	<b>49</b>
Terms .....	49
Pneumatic test assembly setup .....	50
Voltage Calibration .....	51
Pressure verification test .....	52

Blood pressure calibration . . . . .	54
Functional tests. . . . .	56
Temperature Functional Check . . . . .	58
Masimo SpO <sub>2</sub> Functional Check. . . . .	61
Nellcor SpO <sub>2</sub> Functional Check. . . . .	61
<b>7 - Specifications . . . . .</b>	<b>63</b>
Performance . . . . .	63
SpO <sub>2</sub> Specifications . . . . .	65
Mechanical . . . . .	67
Electrical . . . . .	67
Patents . . . . .	67
Battery . . . . .	67
Environmental. . . . .	67
Radio. . . . .	68
Guidance and Manufacturer's Declaration For Spot Vital Signs LXi Radio . . . . .	69
<b>8 - Troubleshooting . . . . .</b>	<b>73</b>
Error Codes. . . . .	73
Radio Test . . . . .	83
Service Work Checklist. . . . .	84
Radio Configuration Utility . . . . .	85
<b>9 - Supplies and Accessories. . . . .</b>	<b>87</b>
Blood Pressure . . . . .	87
Temperature . . . . .	88
Pulse Oximetry . . . . .	89
Miscellaneous. . . . .	92
Service Contracts . . . . .	94
<b>10 - Field Replaceable Units. . . . .</b>	<b>95</b>
<b>11 - Disassembly and Repair . . . . .</b>	<b>101</b>
Tool list . . . . .	101
Key Pad Disassembly . . . . .	105
SpO <sub>2</sub> Circuit Board Disassembly . . . . .	106
Blood Pressure Circuit Board Disassembly . . . . .	108
LCD Inverter Ballast Board Disassembly . . . . .	109
LCD Disassembly . . . . .	109
Pump Disassembly . . . . .	110
RS232-Communication Circuit Board Disassembly . . . . .	110
Fan and Power Circuit Board Disassembly . . . . .	111
Thermometry Circuit Board Disassembly. . . . .	111

<b>12 - Repair Test Specifications</b> . . . . .	<b>115</b>
General Unit Test . . . . .	115
Temperature Option Requirements . . . . .	116
SpO <sub>2</sub> Option Requirements . . . . .	117
Fail Safe Test . . . . .	117





## 1

# Safety Summary

---

## Introduction

All users of the Spot Vital Signs LXi must read and understand the safety summary, and all additional specific warnings and cautions located throughout the documentation.

## Warnings and Cautions

Familiarize all operating personnel with the general safety information in this summary. Specific warnings and cautions are also found throughout this manual.

## General Warnings

A warning statement in this manual identifies a condition or practice, which if not corrected or discontinued immediately, could lead to patient injury, illness, or death.

These warnings pertain entirely to Spot Vital Signs LXi.



**WARNING** The information in this manual is a comprehensive guide to the operation of Spot Vital Signs LXi. For best results, read this manual thoroughly before using the device.

**WARNING** Spot Vital Signs LXi is designed for medical clinician use. Although this manual may illustrate medical spot-check techniques, only a trained clinician who knows how to take and interpret a patient's vital signs should use this device.

**WARNING** Spot Vital Signs LXi is not intended for use in environments that are without health care practitioner supervision.

**WARNING** Spot Vital Signs LXi is not intended for continuous monitoring. **Do not leave the device unattended while taking measurements on a patient.**

**WARNING** To ensure data integrity, save readings and clear the Spot Vital Signs LXi display between patients.

**WARNING** The Spot Vital Signs LXi is not defibrillator proof.

**WARNING** Spot Vital Signs LXi is not intended for use during patient transport.

**WARNING** This device is not suitable for use in the presence of a flammable anesthetic mixture with air or oxygen or nitrous oxide. An explosion may result.



**WARNING** To ensure patient safety, use only accessories and supplies (i.e., cuffs, hoses, temperature probes, SpO<sub>2</sub> sensors, etc.) recommended for or supplied with Spot Vital Signs LXi. Using unapproved accessories with Spot Vital Signs LXi can affect patient and/or operator safety.

**WARNING** Take care to prevent water or other fluid from entering any connectors on the device. Should this occur, dry the connectors with warm air. Check the accuracy of all operating functions.

**WARNING** Every three months, inspect the blood pressure cuff, SpO<sub>2</sub> cable, and other accessories for fraying or other damage. Replace as necessary.

**WARNING** Do not use Spot Vital Signs LXi on patients who are on heart/lung machines.

**WARNING** Electric shock hazard. There are no user-serviceable parts inside Spot Vital Signs LXi other than battery replacement (see "Battery Replacement" on page 46). An operator may only perform maintenance procedures specifically described in this manual. For service, refer the device to an Authorized Service Center.

**WARNING** This device is not intended for hand-held use during operation.

**WARNING** Do not autoclave.

**WARNING** This device complies with current required standards for electromagnetic interference and should not present problems to other equipment or be affected by other devices. As a precaution, avoid using this device in close proximity to other equipment.

**WARNING** Welch Allyn is not responsible for the integrity of any mounting installation. Welch Allyn recommends that the customer contact their Biomedical Engineering Department or maintenance service to ensure professional installation for safety and reliability of any mounting accessory.

**WARNING** The Spot Vital Signs LXi consists of high-quality precision parts. Protect it from severe impact and shock. A qualified service technician must check any Spot Vital Signs LXi that is dropped or damaged for proper operation prior to further use. Do not use the Spot Vital Signs LXi if you notice any signs of damage. Contact the Welch Allyn Customer Service Department for assistance.

**WARNING** Do not use an SpO<sub>2</sub> finger clip sensor and a blood pressure cuff simultaneously on the same limb. Doing so may result in inaccurate pulse rate and perfusion readings.

**WARNING** All signal input and output (I/O) connectors are intended for connection of only devices complying with IEC 60601-1, or other IEC standards (for example, IEC 60950) as appropriate to the device. Connecting additional devices to the Spot LXi may increase leakage currents. To maintain operator and patient safety, it is necessary to consider the requirements of IEC 60601-1-1.

**WARNING** For proper patient electrical isolation, use only a Welch Allyn power supply (4500-101A) to charge Spot Vital Signs LXi and its attached peripheral devices. Do not use an external charger while the printer or weight scale is attached to Spot LXi.

## Blood Pressure Warnings

These warnings pertain to the Spot Vital Signs LXi blood pressure feature.



**WARNING** Spot Vital Signs LXi is not intended to measure BLOOD PRESSURE on neonatal patients. The AAMI SP10:2002 standard defines neonates as children 28 days or less of age if born at term (37 weeks gestation or more); otherwise up to 44 gestational weeks.

**WARNING** To ensure pediatric blood pressure accuracy and safety, the Child Reusable Two-Piece Blood Pressure Cuff (4500-01), Infant Durable One-Piece Cuff (5082-82-4MQ), and the Infant Disposable One-Piece Cuff (5082-92-4MQ) are the smallest cuffs approved for use with young children and infants. The child's arm must fit within the range markings on the cuff.

**WARNING** Avoid compression of the blood pressure hose or cuff tubing of Spot Vital Signs LXi. This may cause system errors to occur in the device.

**WARNING** Patients who are experiencing moderate to severe arrhythmias may give inaccurate blood pressure measurements.

**WARNING** Spot Vital Signs LXi does not operate effectively on patients who are experiencing convulsions or tremors.

**WARNING** Use only Welch Allyn blood pressure cuffs and/or hoses. Using other manufacturers' blood pressure cuffs and/or hoses may produce inaccurate blood pressure readings.

**WARNING** When several blood pressure measurements are taken on the same patient, regularly check the cuff site and extremity for possible ischemia, purpura, and/or neuropathy.

**WARNING** Do not allow a blood pressure cuff to remain on the patient more than 10 minutes when inflated above 10 mmHg. This may cause patient distress, disturb blood circulation, and contribute to injury of peripheral nerves.

**WARNING** Do not place the cuff on any extremity that is used for intravenous infusions or any area where circulation is compromised.

**WARNING** Excessive cuff tightness may cause venous congestion and discoloration of the limb.

**WARNING** Wrapping the cuff too loosely (preventing proper inflation) may result in errors.

**WARNING** Do not change the connector(s) on the blood pressure cuff tubing of this device to luer type. Luer type connectors are commonly used in intravenous infusion systems. Using the luer connectors on blood pressure cuff tubing creates the risk that the blood pressure tubing could be mistakenly connected to a patient's intravenous line, resulting in the introduction of air into the patient's circulatory system.

## Temperature Warnings

These warnings pertain to the Spot Vital Signs LXi temperature feature.

### SureTemp® Plus

These warnings are specific to the SureTemp Plus thermometer option.



**WARNING** Use only Welch Allyn probe covers. Using other manufacturers' probe covers or no probe cover may produce temperature measurement errors and/or inaccuracy.

**WARNING** Always use a probe cover whenever coming into contact with a patient.

**WARNING** Long-term continuous monitoring beyond three to five minutes is not recommended in any mode.

**WARNING** Oral/axillary probes (blue ejection button at top of probe) and blue removable probe wells are used for taking oral and axillary temperatures only. Rectal probes (red ejection button) and red removable probe wells are used for taking rectal temperatures only. Use of the probe at the wrong site will result in temperature errors. Use of the incorrect removable probe well could result in patient cross-contamination.

**WARNING** The thermometer connectors and probe are not waterproof. Do not immerse or drip fluids on these items. Should this occur, dry the connectors and probe with warm air. Check all functions for proper operation and accuracy.

**WARNING** Do not take an axillary temperature through patient's clothing. Direct probe cover to skin contact is required.

**WARNING** Do not autoclave.

**WARNING** Use Welch Allyn single-use disposable probe covers to limit patient cross-contamination.

**WARNING** Incorrect insertion of probe can cause bowel perforation.

**WARNING** Washing hands greatly reduces the risk of cross-contamination and nosocomial infection.

**WARNING** To ensure optimal accuracy, always confirm that the correct mode is selected.

## Braun ThermoScan PRO 4000

These warnings are specific to the Braun ThermoScan PRO 4000 thermometer option.



**WARNING** Keep the probe window clean, dry, and undamaged at all times to ensure accurate measurements. To protect the probe window, always keep the thermometer in the storage cover while transporting or when not in use.

**WARNING** Only use Braun ThermoScan probe covers with this thermometer. Using other manufacturer's probe covers or no probe cover may produce temperature measurement errors and/or inaccuracies. If the thermometer is used without a probe cover attached, clean the lens (see "Braun ThermoScan PRO 4000 Thermometer" on page 44).

**WARNING** Do not autoclave.

**WARNING** The thermometer is not waterproof. Do not immerse or drip fluids on it. Should this occur, dry the thermometer with warm air. Check for proper operation and accuracy.

## SpO<sub>2</sub> Warnings

These warnings pertain to the Spot Vital Signs LXi SpO<sub>2</sub> feature.



**WARNING** Only use Spot Vital Signs LXi with Masimo or Nellcor SpO<sub>2</sub> option with Masimo or Nellcor brand sensors and accessories, respectively. Using the wrong or unapproved sensors or cables may cause improper performance.

**WARNING** The SpO<sub>2</sub> sensor and extension cables are intended for use only for pulse oximetry measurements. Do not attempt to connect these cables to a PC or any similar device.

**WARNING** Before using, carefully read the sensor Directions for Use, including all warnings, cautions, and instructions.

**WARNING** Do not use a damaged sensor or pulse oximetry cable or a sensor with exposed optical components.

**WARNING** Incorrect application or a long duration of use of an SpO<sub>2</sub> sensor may cause tissue damage. Inspect the sensor site periodically as directed in the sensor's Directions for Use.

**WARNING** Certain ambient environmental conditions, sensor application errors, and certain patient conditions may affect SpO<sub>2</sub> readings and pulse signal.

**WARNING** Do not immerse the sensor or patient cables in water, solvents, or cleaning solutions (the sensors and connections are not waterproof). Do not use irradiation, steam, or ethylene oxide for sterilization.

**WARNING** The SpO<sub>2</sub> in the Spot Vital Signs LXi device is not intended for use as an apnea monitor.

**WARNING** Consider the SpO<sub>2</sub> an early warning device. As a trend toward patient deoxygenation is indicated, use laboratory instruments to analyze blood samples to completely understand the patient's condition.



**WARNING** Tissue damage can be caused by incorrect application or duration of use of a Nellcor OxiMax sensor. Inspect the sensor site as directed in the sensor Directions for Use.

**WARNING** Do not use the sensors during magnetic resonance imaging (MRI) scanning. Induced current could potentially cause burns. The MS board pulse oximeter may affect the MRI image, and the MRI unit may affect the accuracy of the oximetry measurements.

**WARNING** Carefully route patient cabling to reduce the possibility of patient entanglement or strangulation.

**WARNING** Failure to cover the Nellcor OxiMax sensor site with opaque material in high ambient light conditions may result in inaccurate measurements.

## General Cautions

A caution statement in this manual identifies a condition or practice, which if not corrected or discontinued immediately, could lead to equipment failure, equipment damage, or data loss.

These cautions pertain to the entire Spot Vital Signs LXi device.



**Caution** If the accuracy of any measurement is in question, check the patient's vital sign(s) with an alternate method and then check to verify the device is functioning properly.

**Caution** Place the device on a secure surface or use one of the optional mounting accessories.

**Caution** Do not place fluids on or near the device.

**Caution** It is recommended that the device is used within stated operating temperature ranges (see "Environmental" on page 67). The device will not meet its performance specifications if used outside these temperatures ranges.

**Caution** Always unplug the AC power transformer from the outlet before moving the mobile stand to a new location.

**Caution** The basket has a three-pound weight limit. Take care not to exceed this limit.

**Caution** Only use a 9V battery with the Healthometer scale. Remove and discard the wall mounted power supply.

**Caution** When using the Healthometer scale, remove the two hex nuts on the RS-232 cable, as supplied, before screwing the cable into the scale base.

## Blood Pressure Cautions

These cautions pertain to the Spot Vital Signs LXi blood pressure feature.



**Caution** Minimize extremity and cuff motion during blood pressure readings.

**Caution** If the blood pressure cuff is not at heart level, note the difference in reading due to the hydrostatic effect. Add the value of 1.80 mmHg (.2 kPa) to the displayed reading for every inch (2.5 cm) above heart level. Subtract the value of 1.80 mmHg (.2 kPa) from the displayed reading for every inch (2.5 cm) below heart level.

**Caution** Proper blood pressure cuff size and placement is essential to the accuracy of the blood pressure determination. See Reusable Two-Piece Cuff Measurements or Durable One-Piece Cuff Measurements of the Directions for Use for sizing information.

**Caution** The position and physiologic condition of the subject can affect a blood pressure reading.

## Temperature Cautions

These cautions pertain to the Spot Vital Signs LXi temperature feature.



**Caution** The SureTemp Plus feature only operates with the probe well in place.

**Caution** Do not use alkaline batteries in the Braun ThermoScan PRO 4000.

**Caution** Biting the probe tip may result in damage to the probe.

## SpO<sub>2</sub> Cautions

These cautions pertain to the Spot Vital Signs LXi SpO<sub>2</sub> feature.



**Caution** The pulse oximeter is calibrated to determine the percentage of arterial oxygen saturation of functional hemoglobin. Significant levels of dysfunctional hemoglobin such as carboxyhemoglobin or methemoglobin may affect the accuracy of the measurement.

**Caution** Some sensors may not be appropriate for a particular patient. If at least 10 seconds of perfusion pulses cannot be observed for a given sensor, change sensor location or sensor type for perfusion to resume.

**Caution** Physiological conditions, medical procedures, or external agents that may interfere with the pulse oximeter's ability to detect and display measurements include dysfunctional hemoglobin, arterial dyes, low perfusion, dark pigment, and externally applied coloring agents such as nail polish, dye, or pigmented cream.

**Caution** When selecting a sensor, consider the patient's weight and activity level, the adequacy of perfusion, the available sensor sites, the need for sterility, and the anticipated duration of monitoring.

## Electrostatic Discharge (ESD)



Electrostatic discharge is a sudden current flowing from a charged object to another object or to ground. Electrostatic charges can accumulate on common items such as foam drinking cups, cellophane tape, synthetic clothing, untreated foam packaging material, and untreated plastic bags and work folders, to name only a few.

Electronic components and assemblies, if not properly protected against ESD, can be permanently damaged or destroyed when near or in contact with electrostatically charged objects. When you handle components or assemblies that are not in protective bags and you are not sure whether they are static-sensitive, assume that they are static-sensitive and handle them accordingly.

- Perform all service procedures in a static-protected environment. Always use techniques and equipment designed to protect personnel and equipment from electrostatic discharge.
- Remove static-sensitive components and assemblies from their static-shielding bags only at static-safe workstations - a properly grounded table and grounded floor mat - and only when you are wearing a grounded wrist strap (with a resistor of at least 1 megohm in series) or other grounding device.
- Use only grounded tools when inserting, adjusting, or removing static-sensitive components and assemblies.
- Remove or insert static-sensitive components and assemblies only with monitor power turned off.
- Insert and seal static-sensitive components and assemblies into their original static-shielding bags before removing them from static-protected areas.











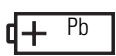

Always test your ground strap, bench mat, conductive work surface, and ground cord before removing components and assemblies from their protective bags and before beginning any disassembly or assembly procedures.







# Symbols

The following symbols are associated with the Spot Vital Signs LXi.

## Safety Symbols

	Identifies information within the manual to avoid injury.		Identifies information within the manual to avoid equipment failure.
	Caution: consult accompanying documents		Internally Powered, Lead Acid Battery
	Handle with Care		Transport Temperature
	Storage Humidity		Recycle
	Class II Equipment	<b>IPX0</b>	Equipment is not protected against the ingress of liquid.
	Type BF Equipment		On/Off
	Recycle the product separate from other disposables, see "Product Disposal" on page 48.		Non-ionizing radiation (RF transmitter)
	Mode of Operation: Continuous		DC Power In

## Button Symbols

	Navigation Buttons		Select
	Blood Pressure		Memory
	Power On/Off		

## Connection Symbols

	USB Connection		Serial Port Connection
---	----------------	--	------------------------

## Agency Symbols



CERTIFIED TO:  
CAN/CSA STD C22.2 NO. 601.1

CONFORMS TO:  
UL STD 60601-1

IEC 60601-1



The CE mark on this product indicates that it has been tested to and conforms with the provisions noted within the 93/42/EEC Medical Device Directive.



European Regulatory Manager  
Welch Allyn Ltd.  
Navan Business Park  
Dublin Road  
Navan, County Meath, Republic of Ireland  
Tel.: +353 46 90 67700  
Fax: +353 46 90 67755

# 2

## Overview

---

### Purpose and Scope

The Spot Vital Signs LXi Service Manual is intended as a reference for maintenance and repair to the field replaceable unit (FRU) level and are listed on [page 95](#).

**Note** If you crack the case some of these parts will need to be calibrated using the repair tool. Internal replacement parts require the Welch Allyn Spot LXi repair software.

This manual provides the technical qualified service person with troubleshooting information, repair procedures, and calibration and performance verification instructions. A technical overview of the Spot Vital Signs LXi subsystems is provided as an introduction to the device's circuitry and pneumatics.

This manual is intended for the technical qualified service personnel. Service training classes on Welch Allyn's products are available. Contact Welch Allyn Technical Service for information.

### Other Applicable Documents

The Spot Vital Signs LXi Directions for Use manual is also available. Refer to this document for information other than maintenance and repair.

Welch Allyn 9600 Plus Calibration Tester Directions for Use - for all models.

Braun ThermoScan PRO 4000 User's Guide - for models 450E0, 45NE0, 45ME0.

Masimo Directions for Use - for models 45MT0, 45ME0.

Nellcor Directions for Use - for models 45NT0, 45NE0.

# Miscellaneous Mounting Accessories

## Wall Mount Kit

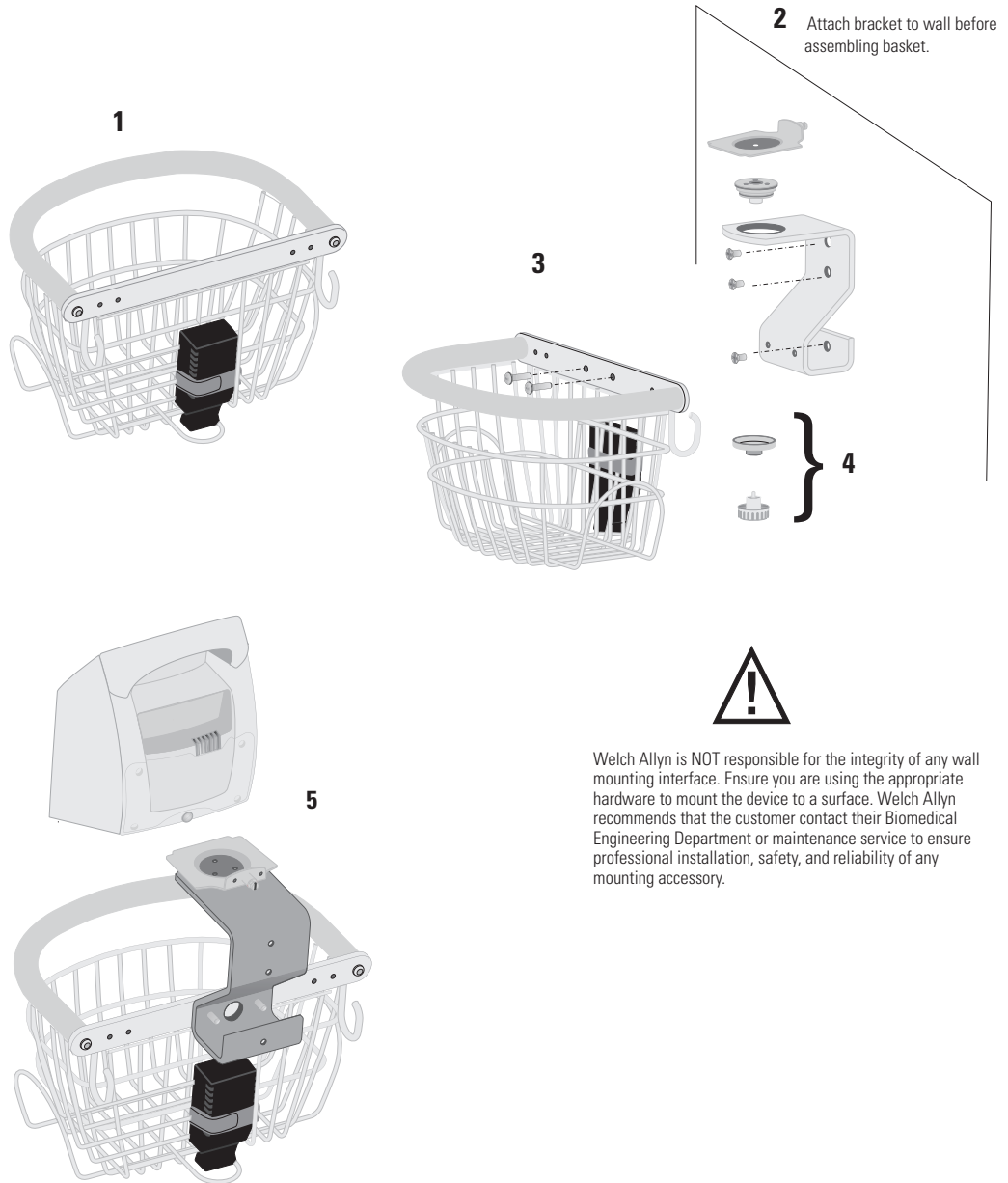

Welch Allyn is NOT responsible for the integrity of any wall mounting interface. Ensure you are using the appropriate hardware to mount the device to a surface. Welch Allyn recommends that the customer contact their Biomedical Engineering Department or maintenance service to ensure professional installation, safety, and reliability of any mounting accessory.

PARTS LIST			
ITEM	DESCRIPTION	QTY	P/N
1	BASKET	1	MIS-1574M
2	AC ADAPTER STRAP	1	STL-1534
3	ADAPTER BLOCK	1	PLS-1497
4	BLOCK CAP	1	STL-1534
5	SCREW	2	SCR-1464

UTILITY BASKET  
12.00" X 8.12" X 7.00"

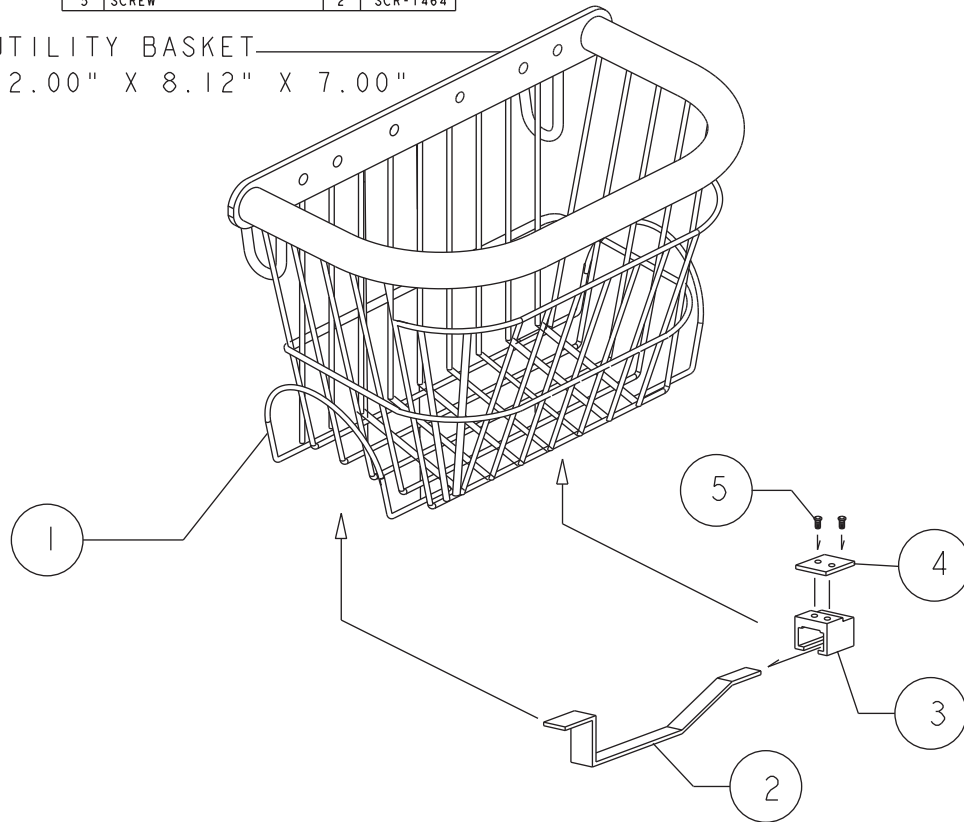

WALL MOUNT BASKET WITH GRAY EPOXY FINISH. SPACE SAVING UNDER MOUNT AC ADAPTER HOLDER.  
BULK SHIPPING PACK OF 8 UNITS. SHIPPING BOX IS 27.00" X 18.00" X 18.00" SHIPPING WEIGHT IS 15 LBS.  
ITEM 1 TO BE PLACED IN A POLY BAG, ITEMS 2-5 TO BE PLACED IN A POLY BAG.

# Mobile Stand Kit

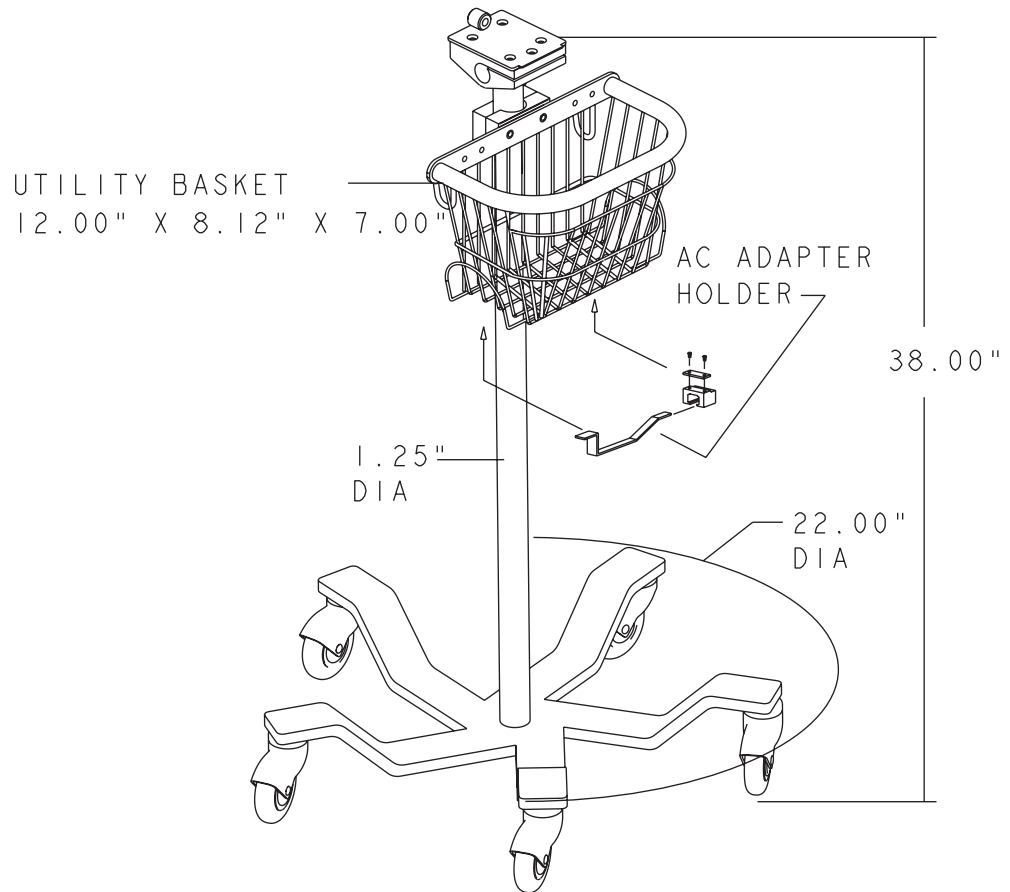

5-LEG, 22" DIAMETER LOW CENTER-OF-GRAVITY DETACHABLE BASE, WITH 3" SOFT RUBBER CASTERS, 2 EA. LOCKING. GRAY EPOXY FINISH. DETACHABLE POLE ASSEMBLY WITH GRAY BASKET AND HANDLE, WITH TILT MOUNT, AND WITH DEVICE MOUNTING PLATE. SHIPPING BOX IS 40.00" X 21.50" X 12.50". SHIPPING WEIGHT IS 31 LBS.

NOTE: ALL DIMENSIONS ARE IN INCHES.

PARTS LIST			
ITEM	DESCRIPTION	QTY	P/N
1	STEEL BASE	1	STL-1005
2	STUD	5	SCR-1258
3	CASTER	3	CAS-1151
4	ESNA NUT	5	SCR-1257
5	WASHER	5	SCR-1341
6	LOCKING CASTER	2	CAS-1163
7	WASHER	1	SCR-1274
8	HEX BOLT	1	SCR-1349
9	TAPERED PIN	1	STL-1032
10	BASE POLE	1	TUB-1268
11	BUSHING	1	PLS-1436
12	BASKET	1	MIS-1574M
13	MOUNT	1SET	PLS-1496
14	TUBE	1	TUB-1202
15	END CAPS	2	MIS-1461
16	SCREW	1	SCR-1567
17	SWIVEL MOUNT	1	PLS-1470
18	SCREWS	3	SCR-1356
19	MOUNT PLATE	1	PLS-1502
20	KNOB	1	KNB-1339
21	RETAINING WASHER	1	SCR-1575
22	SCREW	2	SCR-1295
23	WASHER	2	SCR-1402
24	ACORN NUT	2	SCR-1372
25	SCREW	2	SCR-1559
26	WASHER	2	SCR-1402
27	ESNA NUT	2	SCR-1371
28	AC ADAPTER STRAP	1	STL-1534
29	ADAPTER BLOCK	1	PLS-1497
30	BLOCK CAP	1	STL-1534
31	SCREW	2	SCR-1464
32	MFG LABEL	1	LBL-1526
<b>NOT SHOWN</b>			
	TAMPER PROOF HEX KEY	1	SCR-1320
	TAMPER PROOF SCREW	1	SCR-1574
<b>PACKAGING</b>			
	CARTON	1	PAC-1530
	INSERT	1	PAC-1535
	BASE BOX	1	PAC-1536
	BASKET BOX	1	PAC-1537
	STYROFOAM INSERTS	2	PAC-1538
	INSTRUCTION SHEET	1	LBL-1948

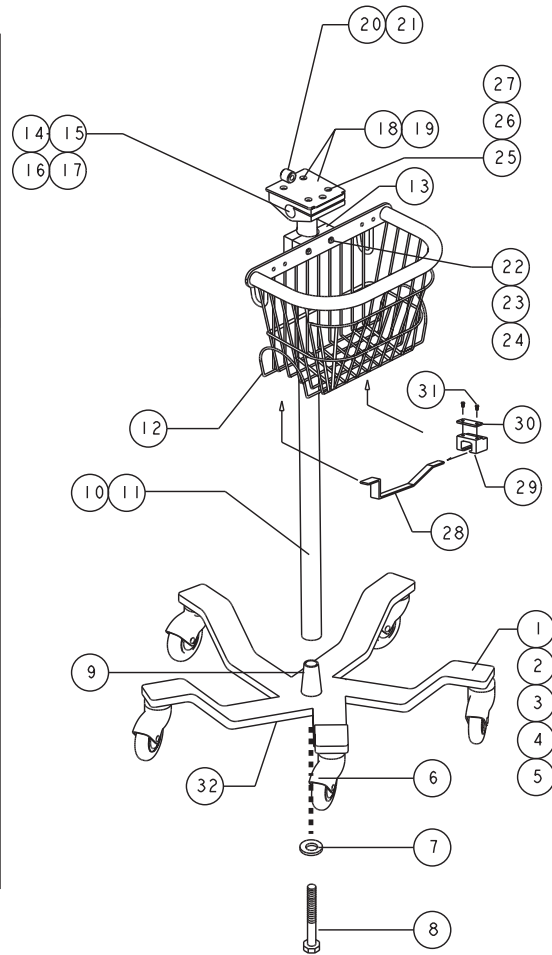

TORQUE ITEM 27 TO 8 - 10 in lbs.  
 BAG ITEMS 7,8 AND 28 - 31, ALONG WITH TAMPER PROOF KEY AND SCREW.

# Radio Mounting Accessory

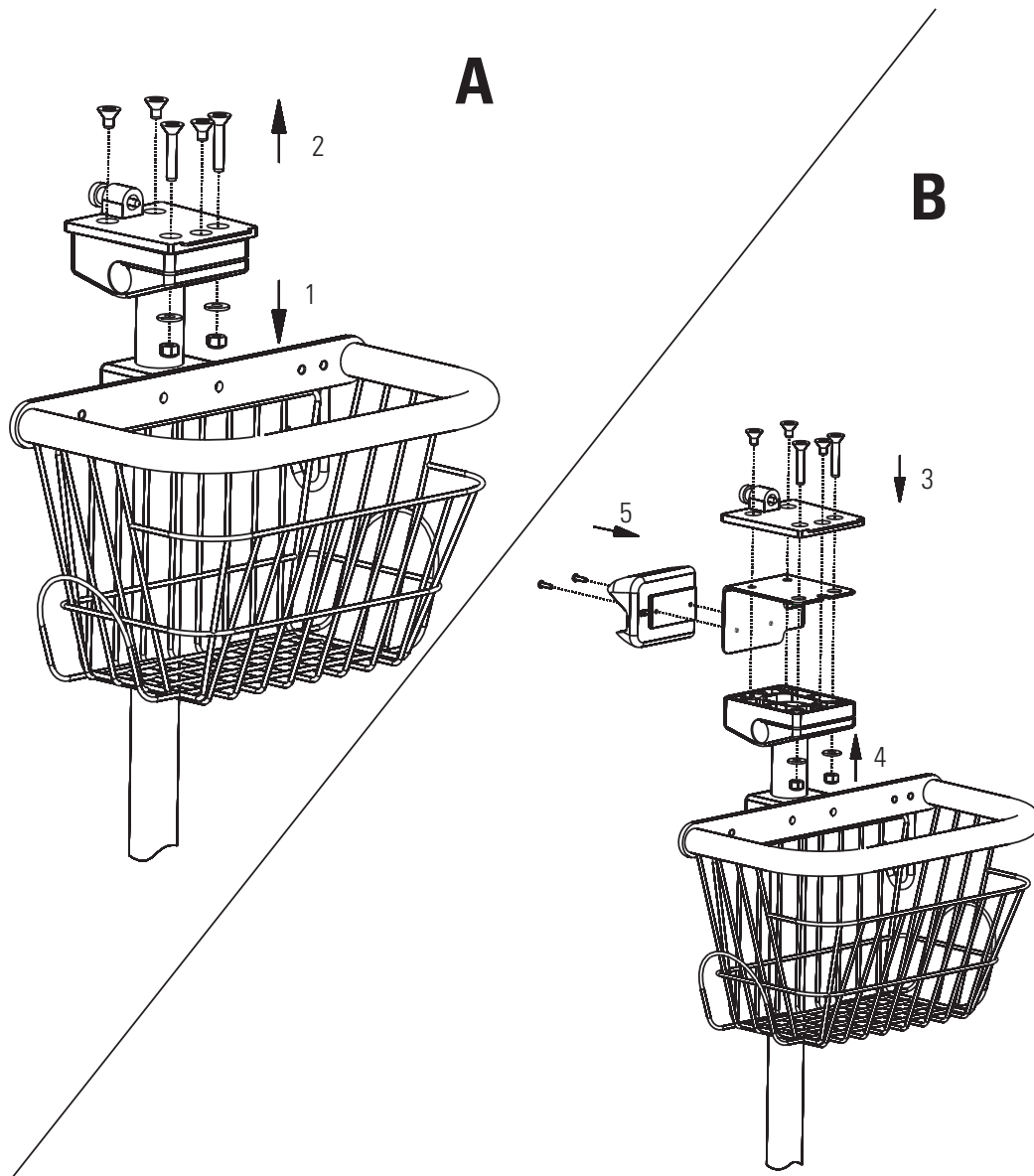



# Barcode Reader Mounting Accessory

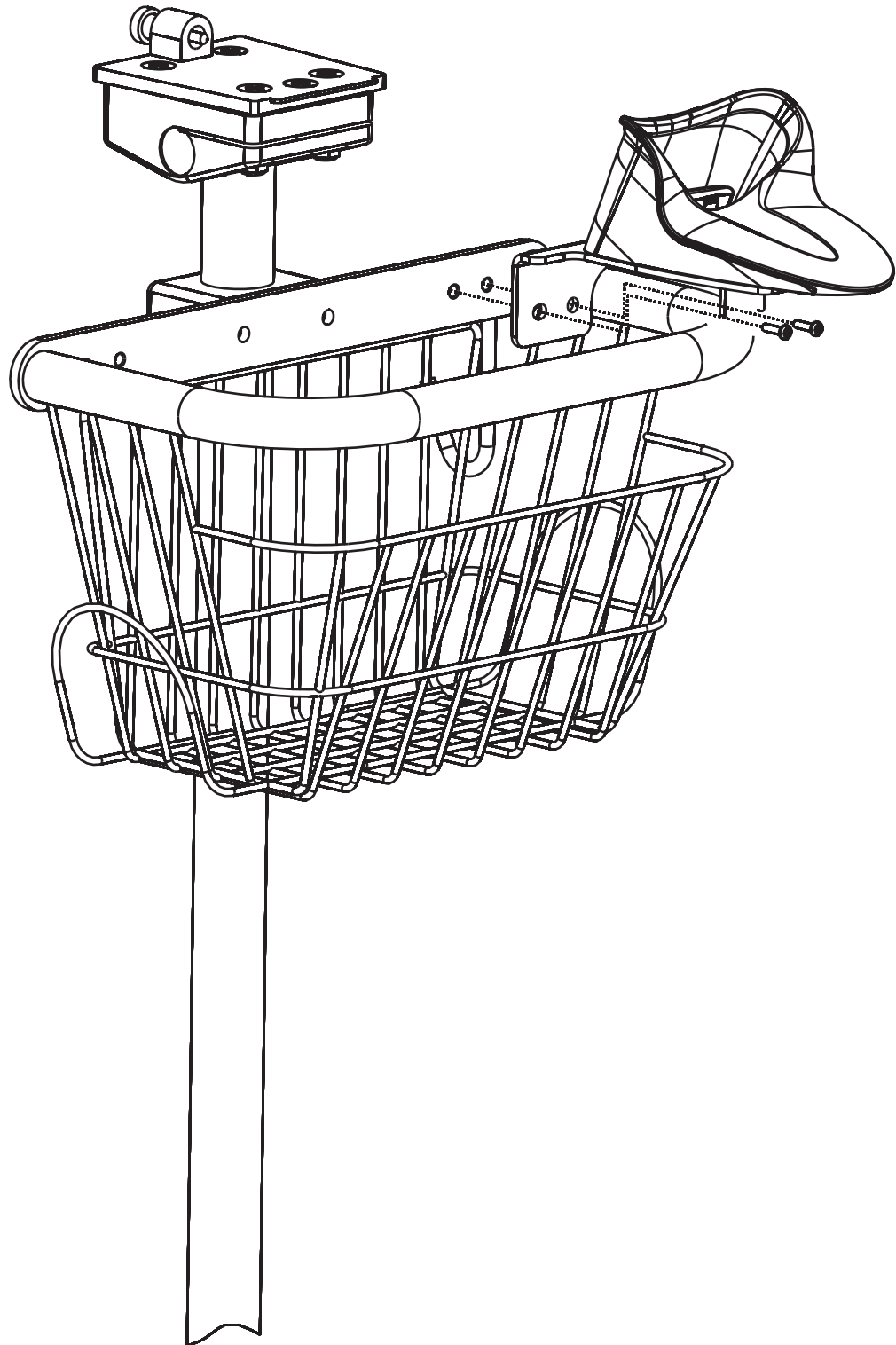

# Warranty

## Spot Vital Signs LXi

Welch Allyn warrants that the Spot Vital Signs LXi Radio products meet the labeled specifications of the products and will be free from defects in materials and workmanship that occur within one year after the date of purchase.

The date of purchase is: 1) the date specified in our records if you purchased the Product directly from us, 2) the date specified in the warranty registration card that we ask you to send to us, or 3) the date of purchase of product from the authorized Welch Allyn distributor as documented from a receipt from said distributor.

This warranty does not cover damage caused by: 1) handling during shipping, 2) use or maintenance contrary to labeled instructions, 3) alteration or repair by anyone not authorized by Welch Allyn, and 4) accidents.

If a Product or accessory covered by this warranty is determined to be defective because of defective materials, components, or workmanship, and the warranty claim is made within the warranty period described above, Welch Allyn will, at its discretion, repair or replace the defective Product or accessory free of charge.

You must obtain a service notification number from Welch Allyn to return your Product before you send it to Welch Allyn's designated service center for repair. Contact Welch Allyn Technical Support.

THIS WARRANTY IS IN LIEU OF ALL OTHER WARRANTIES, EXPRESS OR IMPLIED, INCLUDING BUT NOT LIMITED TO THE IMPLIED WARRANTIES OF MERCHANTABILITY AND FITNESS FOR A PARTICULAR PURPOSE. WELCH ALLYN'S OBLIGATION UNDER THIS WARRANTY IS LIMITED TO REPAIR OR REPLACEMENT OF PRODUCTS CONTAINING A DEFECT. WELCH ALLYN IS NOT RESPONSIBLE FOR ANY INDIRECT OR CONSEQUENTIAL DAMAGES RESULTING FROM A PRODUCT DEFECT COVERED BY THE WARRANTY.

## Accessories

Refer to the manufacturer's Directions for Use for the Masimo and Nellcor finger sensor and cable warranty.

Refer to the Directions for Use provided with the Welch Allyn Blood Pressure Cuff for warranty information.

The SureTemp Plus probe is covered by a one-year warranty and the SureTemp Plus probe well is covered by a 90-day warranty against original defects in material and workmanship. Probe covers are intended for single-use only.

The Braun ThermoScan PRO 4000 is covered by a three-year warranty against original defects in material or workmanship.

The printer is covered by a one-year warranty against original defects in material or workmanship.

The barcode scanner is covered by a five-year warranty against original defects in material or workmanship.

# Service



**Caution** Unauthorized repairs will void the warranty.

A Welch Allyn Service Center must perform all repairs on products under warranty. Qualified service personnel or a Welch Allyn Service Center should repair products out of warranty.

## User Servicable Parts

For user servicable parts available see “Supplies and Accessories” on page 87.

## Technical Assistance

If you have an equipment problem that you cannot resolve, call the Welch Allyn Service Center nearest you for assistance. Technical service telephone support is available on normal business days.

If you are advised to return a product to Welch Allyn for repair or routine maintenance, schedule the repair with the service center nearest you.

Before returning a product for repair, you must obtain authorization from Welch Allyn. Service personnel will give you a Service Notification number. Please note this number on the outside of your shipping box. Returns without a Service Notification number will not be accepted for delivery.

## Field Replacement Units

See “Field Replaceable Units” on page 95.

## Service Loaners

Service loaners are provided, on request, if a Welch Allyn Service Center provides repair service. Loaners for products repaired while under the original warranty, or while under service contract, are provided free of charge and are shipped within 48 hours of notification of need.

For service repairs outside of warranty or contract, loaners are available for a nominal charge and shipment is subject to availability. Loaners are shipped pre-paid; however, this charge is added to the service charges.

## Service Intervals

Verify Spot Vital Signs LXi on an annual basis for blood pressure, temperature, and SpO<sub>2</sub> accuracy.

# Spot Vital Signs LXi Configurations

**Table 1. Available Versions of Spot Vital Signs LXi**

REF	Description
450T0	SureBP with SureTemp Plus Thermometer
450E0	SureBP with Braun ThermoScan PRO 4000 Thermometer
45MT0	SureBP with Masimo SpO <sub>2</sub> and SureTemp Plus Thermometer
45ME0	SureBP with Masimo SpO <sub>2</sub> and Braun ThermoScan PRO 4000 Thermometer
45NT0	SureBP with Nellcor SpO <sub>2</sub> and SureTemp Plus Thermometer
45NE0	SureBP with Nellcor SpO <sub>2</sub> and Braun ThermoScan PRO 4000 Thermometer

## Controls

**Figure 1. Spot Vital Signs LXi Front Panel with SureTemp Plus Thermometer**

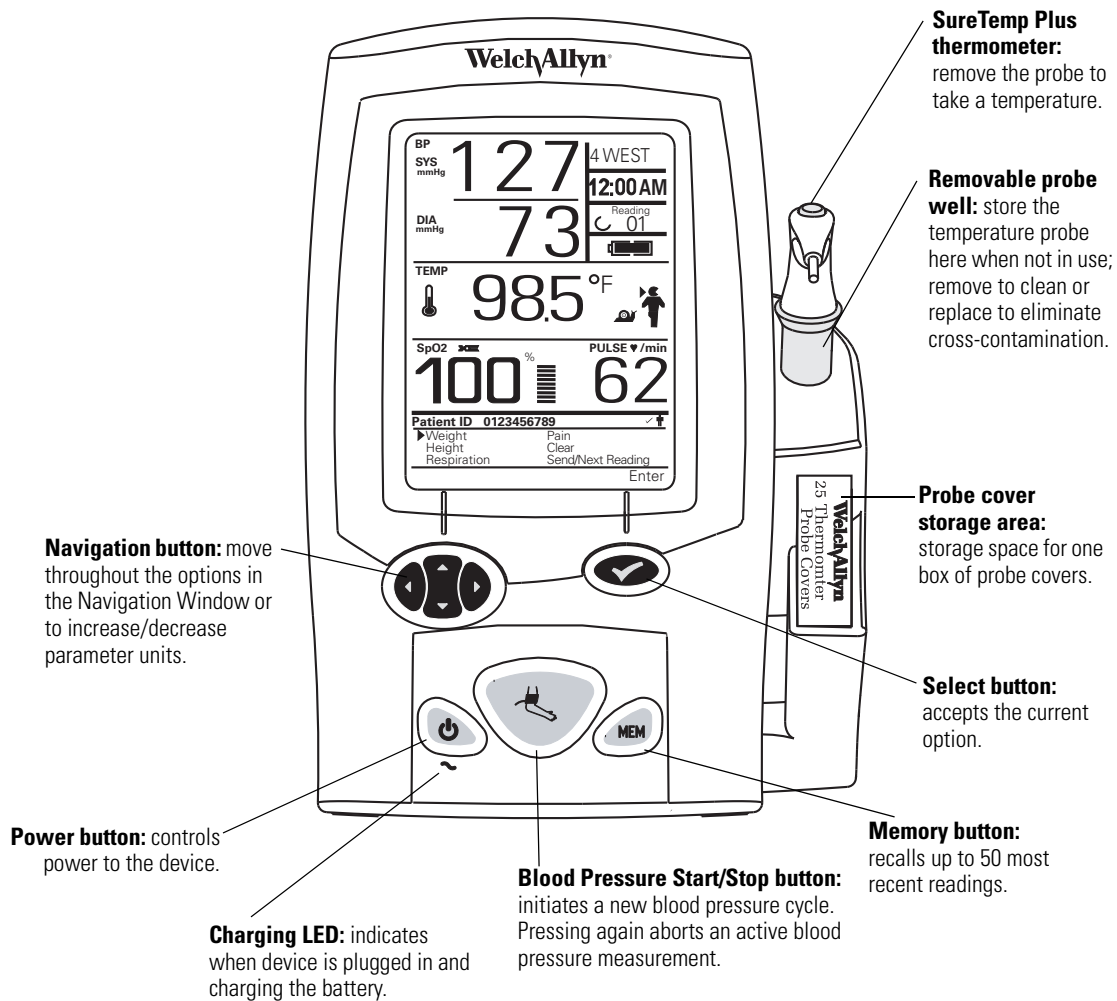

**Figure 2. Spot Vital Signs LXi Front Panel with Braun ThermoScan PRO 4000 Thermometer**

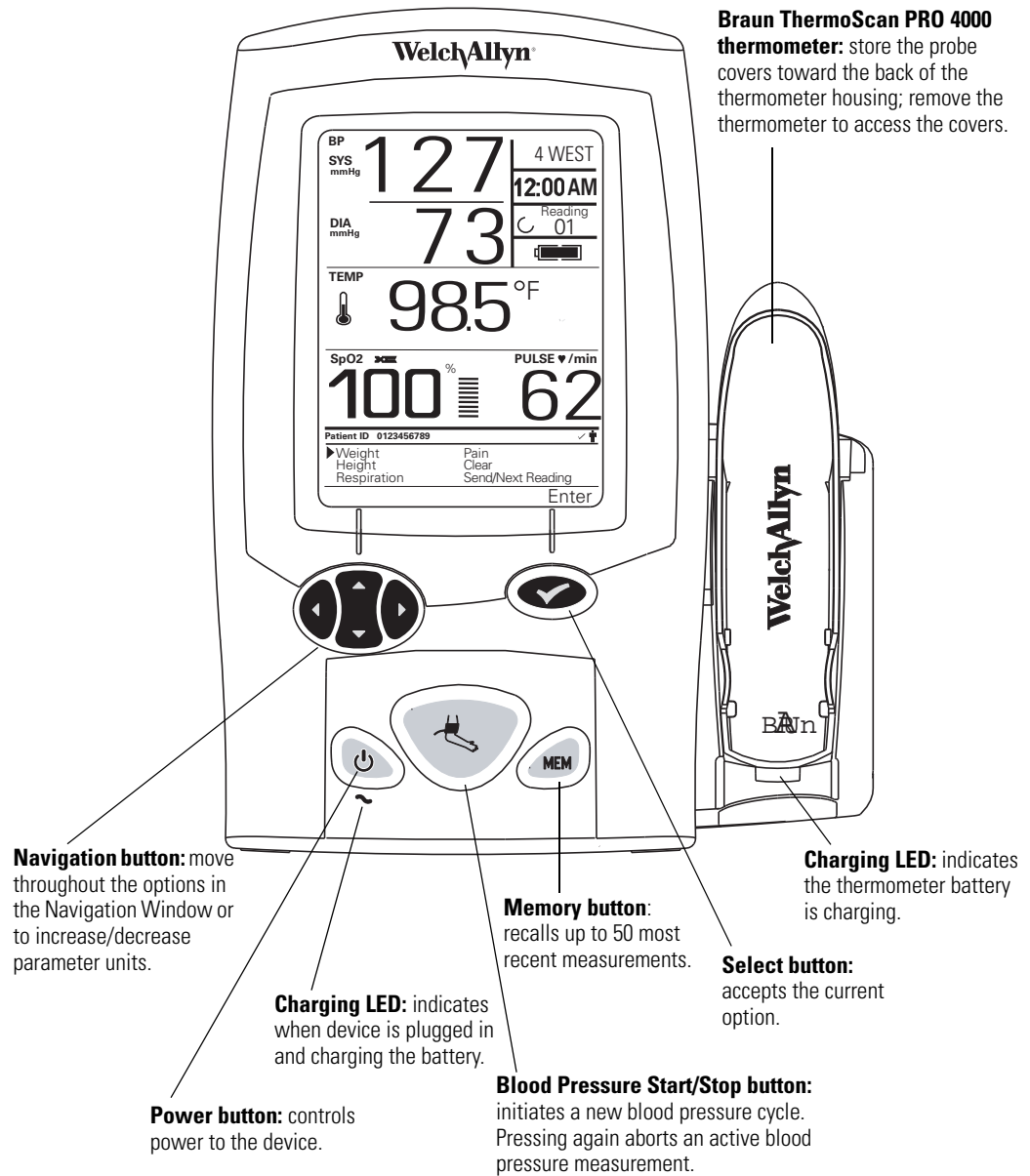

**Braun ThermoScan PRO 4000 thermometer:** store the probe covers toward the back of the thermometer housing; remove the thermometer to access the covers.

**Navigation button:** move throughout the options in the Navigation Window or to increase/decrease parameter units.

**Charging LED:** indicates when device is plugged in and charging the battery.

**Power button:** controls power to the device.

**Memory button:** recalls up to 50 most recent measurements.

**Blood Pressure Start/Stop button:** initiates a new blood pressure cycle. Pressing again aborts an active blood pressure measurement.

**Charging LED:** indicates the thermometer battery is charging.

**Select button:** accepts the current option.

# Display Window

**Note** Before using Spot Vital Signs LXi for the first time, you must program an initial configuration screen.

1. Press the **Power** button. The display window shows the initial configuration screen.

**Figure 3. Initial Configuration Screen**

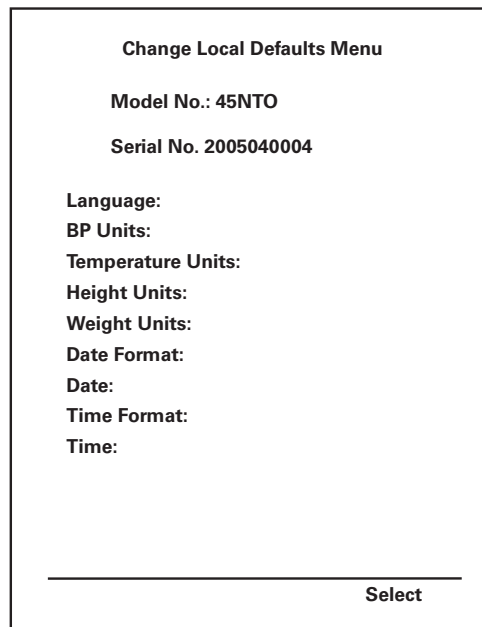

2. Use the **Select** button to access the options and accept the entries, and use the **Navigation** buttons to move through the menu.
3. The word "Exit" appears at the bottom of the list after you have programmed all items in the menu. You must program all items before you can start to use the device.
4. Scroll to Exit and press the **Select** button to save the entries.

The liquid crystal display (LCD) may indicate any of the following: systolic blood pressure (mmHg or kPa), diastolic blood pressure (mmHg or kPa), MAP (mmHg or kPa), temperature (°F or °C), temperature mode, pulse rate, pulse signal level, SpO<sub>2</sub> percent, department location, date, time, record number, height (in or cm), weight (lb or kg), respiration rate, pain level, connectivity signal strength, and battery charge level.

**Figure 4. Display Window**

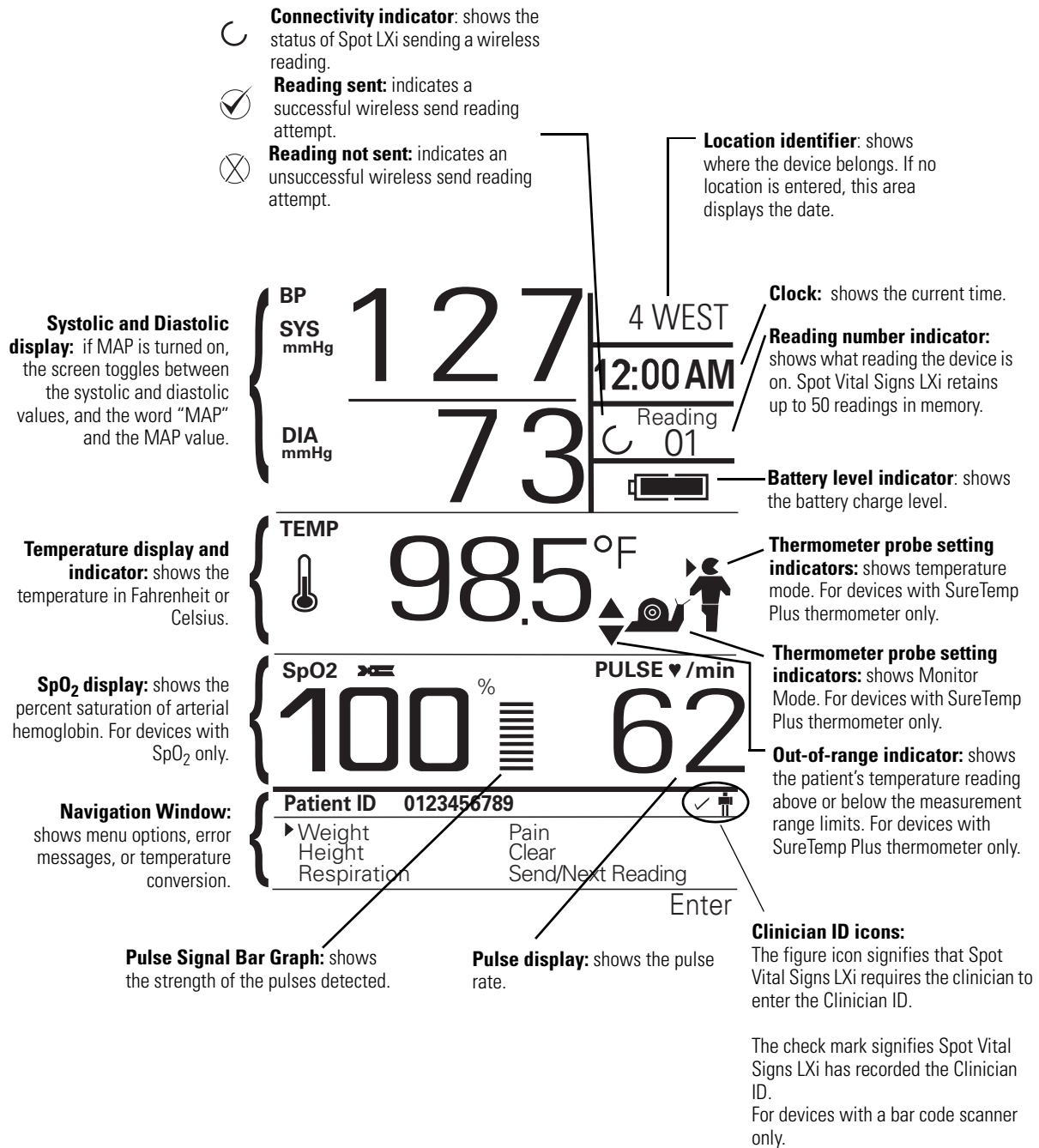

# Connections

Use the following instructions to connect the blood pressure hose, thermometer probe, and optional attachments to the Spot Vital Signs LXi.

**Figure 5. Spot Vital Signs LXi Side and Rear Panel Connections**

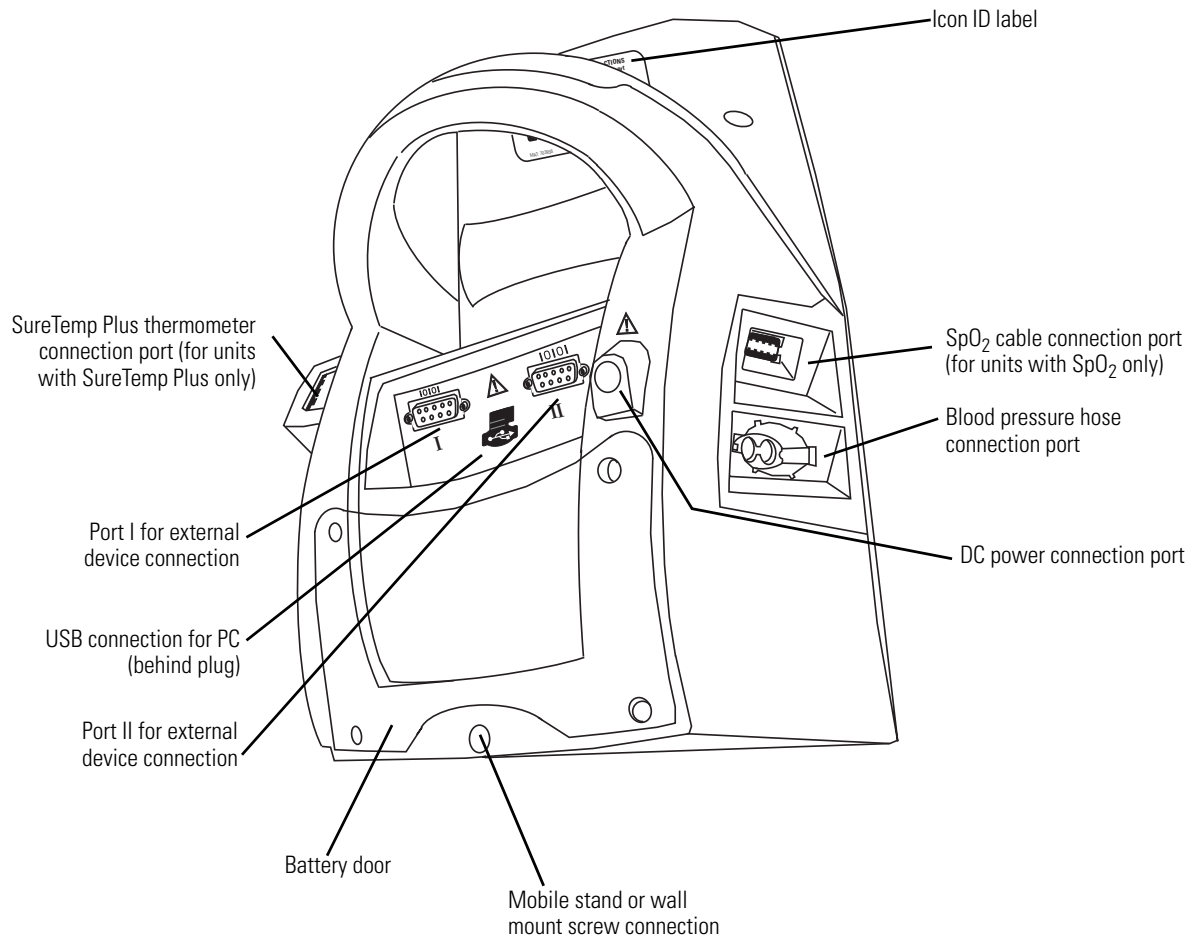



## Braun ThermoScan PRO 4000 Lock

Press the lock tab toward the Braun ThermoScan PRO 4000 thermometer until it clicks. To release the housing, insert the lock release pin into the lock release hole until the lock tab snaps back.

**Figure 6. Spot Vital Signs LXi with Braun ThermoScan PRO 4000 Lock**

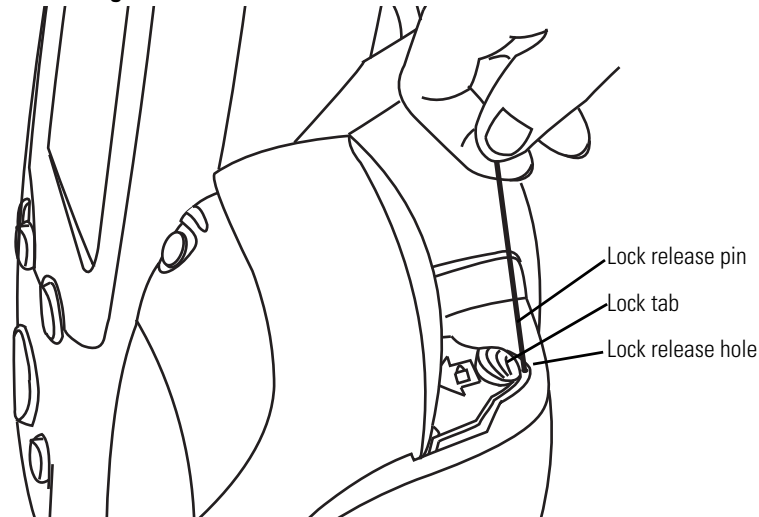

## Blood Pressure Hose and Cuff

Identify and have available the Spot Vital Signs LXi, blood pressure cuff, and the blood pressure hose.

1. Inspect the blood pressure hose; notice that one end has a single, gray connector fitting and the other end has two white fittings.
2. Squeeze the side tabs on the gray connector and completely push the blood pressure hose connector into the blood pressure hose connection port until it clicks into place (see [Figure 5](#) on page 24).
3. Twist the white connectors on the blood pressure hose and cuff connectors together.

## Thermometer

Spot Vital Signs LXi is available with either the SureTemp Plus thermometer or the Braun ThermoScan PRO 4000 thermometer.

### SureTemp Plus

SureTemp Plus is available with two probes and matching wells; one for oral/axillary temperatures (blue ejection button and probe well) and one for rectal temperatures (red ejection button and probe well).



**WARNING** Always use a probe cover whenever coming into contact with a patient.



**Caution** The SureTemp Plus feature only operates with the probe well in place.

1. Align the probe well with the tabs facing up and down into the round opening of the SureTemp Plus housing on the right side of Spot Vital Signs LXi. Push it into place.
2. Align the temperature probe connector with the SureTemp Plus thermometer connection port on the back of the Spot Vital Signs LXi (see [Figure 5](#) on page 24). You can only insert the connector into the port one way.
3. Press the tab on the connector and push it until it clicks into place.
4. Insert the temperature probe into the probe well.

### Braun ThermoScan PRO 4000



**Caution** Do not use alkaline batteries in the Braun ThermoScan PRO 4000 thermometer.

1. Open the package of rechargeable batteries and follow the installation guide provided.
2. Open the box of probe covers as directed on the box and slide the box into the metal guides toward the back of the thermometer housing with the opening at the top and perforation facing forward.
3. Hold the Braun thermometer at a 45° angle then insert the probe and the top of the thermometer into the housing.
4. Lower the bottom portion of the thermometer into the housing until it snaps into place. If you do not properly seat the thermometer, it could fall out of the holder and become damaged.
5. Slide the thermometer housing into the thermometer slot on the right side of the Spot Vital Signs LXi device.
6. Push the lock tab forward to prevent the thermometer housing from falling out of Spot Vital Signs LXi (see [Figure 6](#) on page 25).

To release the lock, insert the lock release pin into the lock release hole.

## SpO<sub>2</sub> Sensor

Spot Vital Signs LXi is available with a wide variety of SpO<sub>2</sub> sensors and ships with a reusable finger clip sensor.

1. Align the shape and pin configuration of the extension cable connector to the SpO<sub>2</sub> cable connection port on the left side of the Spot Vital Signs LXi device.
2. Push the connector firmly into the SpO<sub>2</sub> cable connection port until you hear it click into place (see [Figure 5](#) on page 24).
3. Align the opposite end of the extension cable to the sensor cable connector and firmly push them together.

**Note** Use only Masimo or Nellcor SpO<sub>2</sub> sensors and accessories with the Spot Vital Signs LXi with Masimo or Nellcor configurations, respectively.

## Radio

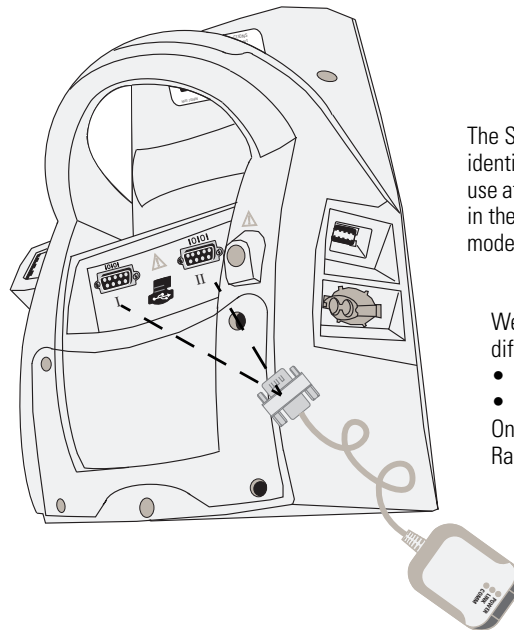

The Spot Vital Signs LXi identifies which serial port to use after activating the Radio in the internal configuration mode.

Welch Allyn offers two different radios:

- 802.11 b radio and
- 802.11 a/b/g radio

Only use Welch Allyn Radios

## Quick Reference Card

Attach the Quick Reference Card to the Spot Vital Signs LXi handle, mobile stand, or wall mount using the supplied plastic cable tie.

## AC Power Transformer

**Note** To assure proper electrical isolation, replace the AC power transformer/charger using only the Welch Allyn specified part.

The operator can use the Spot Vital Signs LXi with AC or battery power (after charging the battery).

1. Insert the round transformer connector into the AC power connection port on the back of the Spot Vital Signs LXi (see [Figure 5](#) on page 24).
2. Insert the line cord into the line connector on the transformer then plug the power cord on the transformer into the AC main power source to charge the battery.

## Battery

Charge the battery for 6 hours before initial use. Charge the device an additional hour if it includes a Braun ThermoScan PRO 4000 thermometer. If there is an external printer, connect the printer to the Spot Vital Signs LXi, enable it in the Internal Configuration Mode (see “Internal Configuration Mode” on page 30 if this is the first time you power on the device, and then [Table 7](#) on page 33), and then charge the Spot Vital Signs LXi for an additional 6-8 hours.

While Spot Vital Signs LXi is charging, the charging LED (~) flashes and the battery level indicator segments on the display continuously sequence. When the battery is fully charged, the charging LED is solid and the battery level indicator is steady with all segments continuously shown on the display.

If the device includes a Braun ThermoScan PRO 4000 thermometer, the charging LED below the thermometer will illuminate orange as it is charging. When the battery is fully charged, the LED will power off.

If the device has an external printer, the charging LED on the printer will flash orange and green when Spot Vital Signs LXi is plugged into the AC main power source.

**Note** There is no hazard associated with leaving the battery in the device, even if the device is not used for long periods of time.

# 3

## Functional Overview

---

This functional verification procedure helps to confirm the proper operation of the Spot Vital Signs LXi and options. This procedure supports the requirements of routine preventative maintenance. It is not necessary to disassemble the Spot Vital Signs LXi to perform this procedure.

For the calibration procedures, see [“Calibration and Verification”](#) on page 49. If the Spot Vital Signs LXi fails certain functional tests or a circuit board is replaced, the device may require calibration. It is necessary to disassemble the Spot Vital Signs LXi for calibration.

Always perform this functional verification procedure after performing any calibration. This procedure contains additional tests that are not included in calibration procedures.

### Self Test

The Spot Vital Signs LXi performs a self-test each time the device is powered on. Press the **Power** button to turn the device on or off. Upon each power up, the display lights up, a beep sounds, and the Spot Vital Signs LXi displays the model and serial numbers. If the internal self-check is successful, the display shows its normal functions (see [Figure 4](#) on page 23) with all values blank, and the device is ready for operation. If the self-check fails, an error code is shown in the Navigation Window (see [“Error Codes”](#) on page 73).

Spot Vital Signs LXi automatically powers off when not used for 30 minutes.

# Internal Configuration Mode

You can change several device operating parameters in the Internal Configuration Mode. When changed, these settings become the default power-up settings. You will also see non-changeable device configurations for technical service purposes.

## To Enter the Internal Configuration Mode:

1. Turn the Spot Vital Signs LXi off.
2. Press and hold the **Select** and **Power** buttons for 5 seconds. The device enters the Internal Configuration Mode and the Configuration Menu screen appears on the display.

**Figure 7. Internal Configuration Mode Menu**

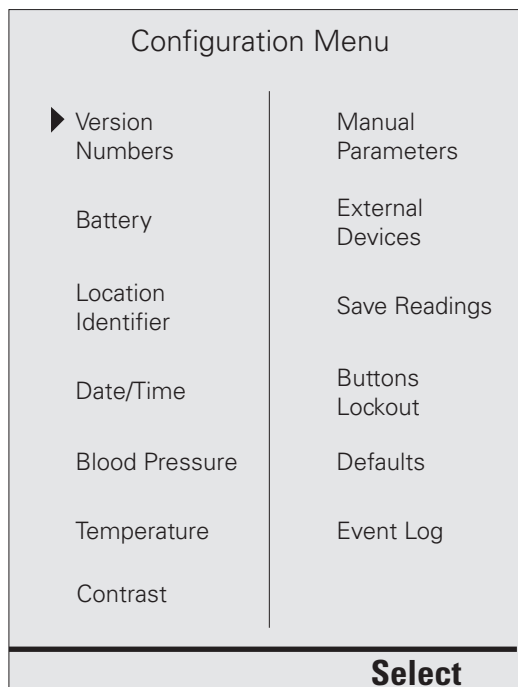

3. Use the **Navigation** buttons to move through the menu options and then press the **Select** button to access the options or accept a change. See the following tables for descriptions of the menu options.
4. Press the **Power** button to exit the Internal Configuration Mode.

**Table 2. Configuration Menu Options**

Setting	Description
Version Numbers*	Displays the software and hardware version numbers in the Spot Vital Signs LXi device.
Battery*	Displays the battery level.
Location Identifier	Allows the entry of the device's location (e.g., the department name). Follow the display prompts and use the <b>Navigation</b> and <b>Select</b> buttons to enter up to 10 characters.
Date/Time	Changes the date and time formats or updates the actual date and time. See <a href="#">Table 3, "Date/Time Menu Options"</a> for available settings.
Blood Pressure	Changes the blood pressure options. See <a href="#">Table 4, "Blood Pressure Menu Options"</a> for available settings.
Temperature	Changes the temperature options. See <a href="#">Table 5, "Temperature Menu Options"</a> for available settings.
Contrast	Changes the Display Contrast options. Use the left/right navigation buttons to adjust.
Manual Parameters	Changes the manual parameters defaults. See <a href="#">Table 6, "Manual Parameters Menu Options"</a> for available settings.
External Devices	Enables or disables available external devices. See <a href="#">Table 7, "External Devices Menu Options"</a> for available settings.
Save Readings	Saves the current patient reading at a preselected time interval or upon request. See <a href="#">Table 8, "Save Readings Menu Options"</a> for available settings.
Buttons Lockout	Secures Spot Vital Signs LXi so unauthorized people cannot use the device or access data without enacting the proper key sequence. To override the buttons lockout feature, simultaneously press the <b>Left Navigation</b> button and the <b>Select</b> button.
Defaults	Allows the user to select the default settings for the device and reset the unit to the default settings. See <a href="#">Table 9, "Change Local Defaults Options"</a> for available settings.
Event Log*	Displays the recent button presses, errors, measurements, measurement sites, battery state changes, and patient reading send events.

\* Displayed information only; operator cannot change.

**Table 3. Date/Time Menu Options**

Setting	Description
Date Format	Displays the date in one of the following styles: <ul style="list-style-type: none"> <li>• mm/dd/yyyy example: July 16, 2005 = 07/16/2005</li> <li>• dd/mm/yyyy example: 16 July 2005 = 16/07/2005</li> </ul>
Date	Changes the date on the Display Window and in patient readings. If a location is entered (see " <a href="#">Location Identifier</a> " in <a href="#">Table 2, "Configuration Menu Options"</a> ), the date will not appear on the Display Window; the location will.
Time Format	Displays the time in one of the following styles: <ul style="list-style-type: none"> <li>• 12-hour example: 5:00 PM</li> <li>• 24-hour example: 17:00</li> </ul>
Time	Changes the time on the Display Window.

**Table 4. Blood Pressure Menu Options**

<b>Setting</b>	<b>Description</b>
BP Calibration Check	Prepares the Spot Vital Signs LXi for calibration. Only qualified personnel should verify the Spot Vital Signs LXi blood pressure calibration. For more details, see "Blood pressure calibration" on page 54.
Blood Pressure Units	mmHg or kPa.
Mean Arterial Pressure (MAP)	On or off.

**Table 5. Temperature Menu Options**

<b>Setting</b>	<b>Description</b>
Temperature Units	Fahrenheit (°F) or Celsius (°C).
Temperature Mode	SureTemp Plus models only: Oral, Pediatric Axillary, Adult Axillary, and Last Mode. In Last Mode the device takes the next temperature in the mode in which the previous temperature was measured. Rectal Mode is available only when the rectal probe (red ejection button) and probe well are attached.

**Table 6. Manual Parameters Menu Options**

<b>Setting</b>	<b>Description</b>
Height	On or off.
Height Units	Inches (in) or centimeters (cm).
Height Default	Changes the default patient height displayed in the Navigation Window.
Weight	On or off. Even if weight is enabled here, if weight scale is enabled in the External Devices Menu, you cannot manually enter the weight.
Weight Units	Pounds (lb) or kilograms (kg).
Weight Default	Changes the default patient weight displayed in the Navigation Window.
Respiration	On or off.
Pain Level	On or off.



**Table 7. External Devices Menu Options**

Setting	Description
Information System	On or off. You must enable this option to send patient readings wired or wirelessly.
Barcode Patient ID	On or off. You must enable this option to send patient readings wirelessly.
Barcode Clinician ID	On or off. You must enable this option to require mandatory sign in of a clinician.
Mandatory Sign In	Yes or no. You must enable this option to require the sign-in of the clinician.
Clear on Send/Save:	Yes or no. You must enable this option to clear the Clinician ID after sending or saving the measurements.
Clear on Power Cycle:	Yes or No. You must enable this option to clear the Clinician ID after powering the Spot Vital Signs LXi off.
Weight Scale	On or off. Spot Vital Signs LXi connects to a scale and the weight shows on the display window (see "Spot Vital Signs LXi Technical Overview" on page 35 for scale details).
Wireless Module	None or 802.11 B. You must enable 802.11 B to send patient readings wirelessly. The radio is available as an accessory only with Welch Allyn Connex.
Printer	On or off.
Printer Paper	Plain or labels. Only available if the Printer is enabled.

**Table 8. Save Readings Menu Options**

Setting	Description
Save Mode	Manual or automatic. If automatic, Spot Vital Signs LXi saves readings at a preselected time interval. For either option, Spot Vital Signs LXi automatically saves the measured parameters into memory before automatically powering off when not used for 30 minutes.
Auto Save Interval	Changes the amount of time before automatically saving the current patient reading. Only available if Automatic Save Mode is enabled.
Reading Full Action	Auto Overwrite, Ask Overwrite, Do not Overwrite. Spot Vital Signs LXi can save 50 patient readings in memory. Upon reaching reading 51, the device may automatically overwrite reading 1, ask the user if he/she wants to overwrite reading 1, or disable the ability to take another reading until at least one reading is erased.

**Table 9. Change Local Defaults Options**

Setting	Description
Language	English, Dansk, Nederlands, Suomi, Français, Deutsch, Italiano, Norsk, Español, Português, Svenska, or Chinese.
BP Units	mmHg or kPa.
Temperature Units	Fahrenheit (°F) or Celsius (°C).
Height Units	Inches (in) or centimeters (cm).
Weight Units	Pounds (lb) or kilograms (kg).
Date Format	Displays the date in one of the following styles: <ul style="list-style-type: none"> <li>• mm/dd/yyyy example: July 16, 2005 = 07/16/2005</li> <li>• dd/mm/yyyy example: 16 July 2005 = 16/07/2005</li> </ul>
Time Format	Displays the time in one of the following styles: <ul style="list-style-type: none"> <li>• 12-hour example: 5:00 PM</li> <li>• 24-hour example: 17:00</li> </ul>



# 4

## Spot Vital Signs LXi Technical Overview

---

### System Description

The Spot Vital Signs LXi automatically measures systolic and diastolic pressure (excluding neonates), pulse rate, temperature (oral, adult axillary, pediatric axillary, rectal, and ear), and pulse oximetry (SpO<sub>2</sub>) as well as calculates Mean Arterial Pressure (MAP). Furthermore, Spot Vital Signs LXi allows the entry of height, weight, respiration rate, and pain level. Spot Vital Signs LXi also calculates Body Mass Index (BMI) following height and weight entry.

The device is intended to be used by clinicians and medically qualified personnel. It is available for sale only upon the order of a physician or licensed health care provider.

Refer to the Spot Vital Signs LXi Directions for Use manual for complete information.

### Battery System

Spot Vital Signs LXi includes a 6 Volt, 6 amp-hour sealed lead-acid battery that supplies all power to the device. An external power supply charges the battery. The battery is always on-line (floated) rather than switching out when attached to the external power supply.

Spot Vital Signs LXi uses a fuse and a shunt diode for protection against reverse battery connections. The fuse is located on the main board in the negative battery line and a reverse battery connection causes it to blow and require repair. The negative line location is more likely to short the battery (+) wire to ground than short the battery (-) wire to the VBUS node.

### Battery Charger

Provides two levels of power to fast-charge or to float the battery at fixed voltages using software control. The fast-charge level rapidly brings the battery up to near-full capacity (7 Volts) using software to not overcharge the battery. The float level, set per the manufacturer's recommendation, slowly tops-off the battery and can stay on indefinitely.

### "CPU I/O" Power Supply

Provides power to the I/O pins of the DragonBall MPU and the attached peripheral IC's. The nominal voltage is set to a value of 3.15 Volts so that both the 3.0 Volt MPU and 3.3 Volts peripherals can operate within specifications. Spot Vital Signs LXi uses buck switching topology for efficiency and an on-off power latch directly controls the power supply.

## Standby Mode

The Standby Mode conserves battery power. The device goes into Standby Mode if it is not used for two minutes. Press any button to bring the Spot Vital Signs LXi out of Standby Mode.

## CPU Core Power Supply

Powers the MPU core only and operates at the recommended Dragonball voltage range of 1.8 +/- 0.1 Volts; 2.0 Volts absolute max.

The +3.15 Volt supply powers the +1.8 Volt supply for efficiency and, more importantly, for power sequencing. During power-on the +1.8 Volt supply cannot exceed the +3.15 Volt supply. The R207/C182 further delays the +1.8 Volt supply. During power-off, D106 prevents the +1.8 Volt supply from exceeding the +3.15 Volt supply by more than a partial diode drop.

## +5V Supply

Provides supply to miscellaneous loads that require more than 3.15 Volts. The Power Latch controls the supply and the average load current is small, so efficiency is not important.

## Clock/Calendar Power

The Clock/Calendar U19 receives power from two sources. During power on the clock runs from the +5 Volt supply and during power down the clock receives power directly from the battery potential using a voltage divider. Capacitor C131 provides power to the U19 during the battery exchanges. Zener D102 prevents overvoltage to U19 in the case of operation directly from the charger.

## Mod F NIBP Power

This module is powered directly from VBUS through an EMI filter. Software via BP-PWR-ON-BAR controls the power. Level shifter Q115 / Q104 assures that the module remains off when the MPU is unpowered.

## SpO<sub>2</sub> and Thermometer Power

A common structure supplies SpO<sub>2</sub> and thermometry. A single push-pull driver delivers squarewave power to a pair of isolation transformers, one for SpO<sub>2</sub> and the other for thermometry. THERM-PWR-BAR activates the driver under software control. Level shifter Q118, Q119 assures that the module remains off when the MPU is unpowered.

In the push-pull (forward) configuration, VBUS is multiplied by the transformer turns ratio and supplied to the input of the rectifier diodes. This is filtered and passed through low-noise 5-Volt linear regulators to supply power to the parameter modules.

## LCD Power

The LCD data interface connects directly to the +3.15 Volt MPU I/O power supply. This powers the driver ICs inside the LCD pane and assures the data interface to the LCD is always powered when the unit is powered.

The contrast (bias) supply to the LCD panel and the LCD CCFL backlight both derive power indirectly from a pre-regulator. A software control can shut down the pre-regulator. For efficiency, it is implemented as a buck switcher operating directly from the battery. The primary purpose of the pre-regulator is to protect the backlight inverter / ballast from battery voltages that it cannot tolerate and to control current out of the unregulated ballast. The voltage is set to the low side of 5 Volts to reduce battery consumption, while still driving the CCFL with adequate voltage.

## External Load (RS-232) Power

There are two power outlet means on the Spot Vital Signs LXi – RS-232 port power and the Braun PRO 4000 charger.

Two isolated power supplies provide power to each of the external RS-232 ports. This power is available to external devices on pin 9 of each serial connector whenever the software enables the corresponding RS-232 port.

## SureTemp Plus Thermometer Interface

The SureTemp Plus OEM module is located in an optional pod and is connected to the main PCB via a flex cable. The Thermometer Probe connection is located on a separate PC board. It is connected to the SureTemp Plus OEM module by a ribbon cable. The electrical interface to the thermometer pod is a 6-pin ribbon connector, Molex 52271-0690 or equivalent.

## Braun ThermoScan PRO 4000 Thermometer Interface

The interface to the Braun ThermoScan PRO 4000 thermometer is located in the optional pod and connects to the main PCB via a flex cable. The communications link is a single duplex current loop that also charges the Braun battery pack.

The presence or absence of current passing through the Braun ThermoScan PRO 4000 charge contacts controls the interface charge LED, located within the pod, which mimics the Braun ThermoScan Pro 4000 Base Station (type 6021).

## SpO<sub>2</sub> Description

A shielded flat-flex cable connects the user interface sensor connector J8 to the SpO<sub>2</sub> electronics.

The Masimo SpO<sub>2</sub> module mates to the Masimo Adaptor Board that, in turn, mates to the Main board. This provides power and communications to the module from the Main board.

The Nellcor SpO<sub>2</sub> module mounts directly to the Main board. This provides power and communications to the module, and brings the sensor signals to the main board where EMI and ESD can be controlled. The sensor signals pass through the main board to the mating connector for the shielded flat-flex cable.

## Radio Description

For radio description, refer to the manufacturer's Directions for Use.

The radio interfaces to the Spot Vital signs LXi through an RS-232 female connector with a 9-pin male/female null modem connection.

**Figure 1. 9-pin Null Modem Pinout**

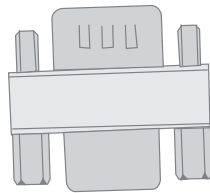

MA 0051 (DB9M/F) Adapter Pin out:

09 Male	09 Female
2	3
3	2
4	1 + 6
5	5
1 + 6	4
7	8
8	7
9	9
G	G

## Bar Code Scanner Description

The Spot Vital Signs LXi has a 2D scanner (IMAGETEAM™ 4600). This scanner is programmed specifically for Welch Allyn. Scanners not purchased through Welch Allyn will not work with the Spot Vital Signs LXi.

### 4600SF031C Settings

Parameter	Setting	Factory Default
Terminal Interfaces:		
Baud Rate:	9600	38400
Data Bits:	7	8
Stop Bits:	1	1
Parity:	Even	None
Handshaking:	None	None
Output:		
Beeper - Good Read:	Off	On
Beeper Volume - Good Read:	Off	Medium
Trigger Mode:	Manual Trigger, Low Power	Manual/Serial Trigger
Lower Power Time Out:	5 seconds	-

Parameter	Setting	Factory Default
Data Editing:		
Prefix1:	<STX><SOH><DC2> (Ctl-BAR)	None
Suffix1:	<CR><LF>	<CR><LF>

**NOTES:**

1. Applies to all symbologies.
2. Select the he <CR><LF> prior to revising the Terminal Interface parameters.

## Output Format

The data accepted as a valid bar code reading consists of an ASCII text string composed of three elements: the prefix, the message consisting of the bar code data, and the suffix. The format of the string is as follows:

“<STX><SOH><DC2>AA...AA(CR><LF>”

where:

Field	Description
STX	Start of Text character, 0x02.
SOH	Start of Header character, 0x01.
DC2	Device Control 2 character, 0x12.
A	Message data consisting of alpha-numeric chacters in the range 0x20 through 0x7E. The message length can range from 0 to 20 characters.
CR	Carriage return character, 0x0D.
LF	Line feed character, 0x0A.

- Note**
1. Spot Vital Signs LXi issues a single beep for valid bar codes and displays the message scanned in on the units display. If a bar code is invalid, Spot Vital Signs displays nothing.
  2. Spot Vital Signs LXi treats bar codes longer than 20 characters as invalid.
  3. Spot Vital Signs LXi checks the parity bit of every character received. If a parity error is detected in the preamble, Spot Vital Signs LXi ignores the remainder of the bar code (no beep issued). If a parity error is detected in the message data or suffix, Spot Vital Signs LXi treats the bar code as invalid.
  4. Refer to the bar code scanner manual for a list of supported symbologies.

## Interface

The bar code scanner interfaces to Spot Vital Signs LXi through an isolated RS-232 DB-9 female connector. A started 4600SF031C cable (Part #42204253-01 RS232, 9PIN D, HHP 0204 REF F) is required for use with the scanner.

## Printer Description

All models of the Ap1300 printer use an industry standard RS-232 interface. The default parameters are 9600 baud, 8 data bits, 1 stop bit, and no parity.

Serial data is expected in standard RS-232C format with -12 Volt meaning 'mark' or '1' and +12 Volt a logical '0', with reference to the common ground. The serial data output line, TxD, transmits XON/XOFF and status information to the host at the same Baud rate and in the same format as the serial data input. The hardware busy line is true (nominal -12 Volt) when busy. Both serial output lines will relax to approximately 0 Volt when the Ap1300 is in sleep mode and the user must allow a short period after awakening before relying on the values of these signals.

The Ap1300 has three operating modes, when not actually printing.

Idle Mode	Ready to accept data, but no data are in the buffer awaiting printing and the printer motor is not running.
Sleep Mode	Effectively switched off.
Spool Mode	Active, but storing data for later printing.

Different color combinations on the front-panel LED indicate the modes. No light is emitted in sleep mode.

**Table 1. LED Pattern Table**

Pattern	Battery	Buffer Mode
Constant Green	Running	Normal
Fast Flashing Green	Running	Spool *
Long Green - Short Red	Battery Low	Normal
Short Green - Short Red	Battery Low	Spool *
Short Green - Long Orange	Trickle Charging	Normal
Long Orange Flash	Trickle Charging	Spool *
Fast Flashing Orange	Fast charging	Spool (Printing prohibited)
Fast Flashing Red	Error Condition	Spool (Printing prohibited)
No Light	Flat or in sleep mode	

\* Spool may have resulted from Paper Out or Head Up conditions)

No hardware power switch is fitted, as power control is either automatic or by command from the host computer. To save power, the printer enters sleep mode after a period of inactivity, factory-set to 30 seconds, but programmable from the host. It can also be programmed to stay idle indefinitely or to go to sleep on command.

The Ap1300 utilizes Fujitsu FTP-628MCL 103 printer mechanism, with a fixed (parallel) print head with 384 horizontally-arranged thermal elements. A stepper motor advances the paper and the printing takes place in a single-dot row for each step of the paper. Each printed dot is approximately 1/8 mm square. The printing speed and dot density are controlled according to the battery voltage and the head temperature.

The Spot Vital Signs LXi provides two levels of power to fast-charge or to float the battery at fixed voltages using software control. The fast-charge level rapidly brings the battery



up to near-full capacity (7 Volts) using software to not overcharge the battery. The float level, set per the manufacturer's recommendation, slowly tops-off the battery and can stay on indefinitely.

## Interconnect Diagram

Item	Description	Item	Description
A1	PCA, Main, Spot Vital Signs LXi	W1	Assy, Power Harness, Spot Vital Signs LXi
A1-F1	Fuse, FlastBlo, 5A	W1-A1	PCA, Power Interface, Spot Vital Signs LXi
A2	PCA, Serial Interface, Spot Vital Signs LXi	W2	Flex, Main, Spot Vital Signs LXi
A3	Display, LCD, 320 x 240, Mono	W3	Cbl Flx, 1/2mm, 15 POS
A4	Inverter, LCD	W4	Assy, Ballast Harness, Spot Vital Signs LXi
A5	Assy, Battery, Spot Vital Signs LXi	W5	Assy, LCD Gnd Harness
A5-F1	Wire Protection Fuse	W6	Assy, Cable, Flat Flex, SpO <sub>2</sub>
A6	Assy, Fan Unit Cooling		Wire Clip, Side Entry, .375 Wide
A7	PCA, Masimo Adapter, Spot Vital Signs LXi		Foam Strip, 2 Sided Adhesive
A8	Masimo MS-11 SpO <sub>2</sub>	W7	Cbl, Flx, 1mm, 6POS
	Shield, Masimo EMI	W8	Cbl, Flx, 1mm, 8POS
	Tape, Copper, Masimo Shield	W9	Cbl, Flx, Braun, Spot Vital Signs LXi
A9	PCA, SureTemp Plus, OEM w/o EDAC		
A10	PCBA, BP OEM, (MOD F)		
A11	Assy, Pump, and Tubing, Spot Vital Signs LXi		
A11-F1	Filter, Air, 1/8 Barbs		
A12	Assy, Transducer Tubing, Spot Vital Signs LXi		
A13	PCA, EDAC, Spot Vital Signs LXi		
A14	Nellcor MP506 SpO <sub>2</sub> PCB		
A15	PCA, Braun Interface, Spot Vital Signs LXi		

### Wire Color

BLK	Black
BRN	Brown
RED	Red
ORN	Orange
GRN	Green
BLU	Blue
PNK	Pink

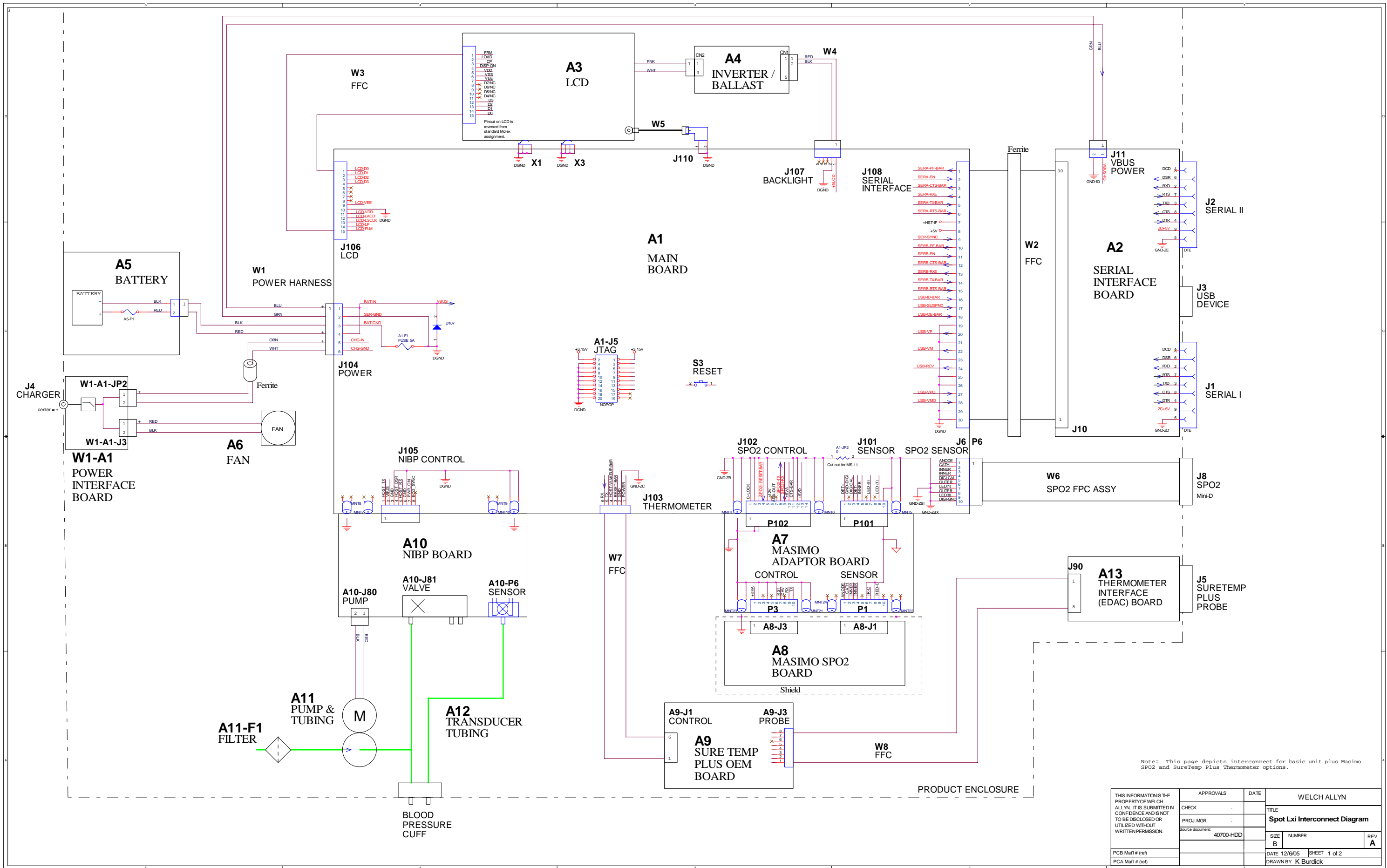

THIS INFORMATION IS THE PROPERTY OF WELCH ALLYN. IT IS SUBMITTED IN CONFIDENCE AND IS NOT TO BE DISCLOSED OR UTILIZED WITHOUT WRITTEN PERMISSION.

PCB Mat'l # (ref)  
PCA Mat'l # (ref)

APPROVALS	DATE	WELCH ALLYN	
CHECK		TITLE	
PROJ. MGR.		Spot Lxi Interconnect Diagram	
Source document:	40700-HDD	SIZE	NUMBER
		B	
		DATE	SHEET
		12/6/05	1 of 2
		DRAWN BY K Burdick	
		REV	A

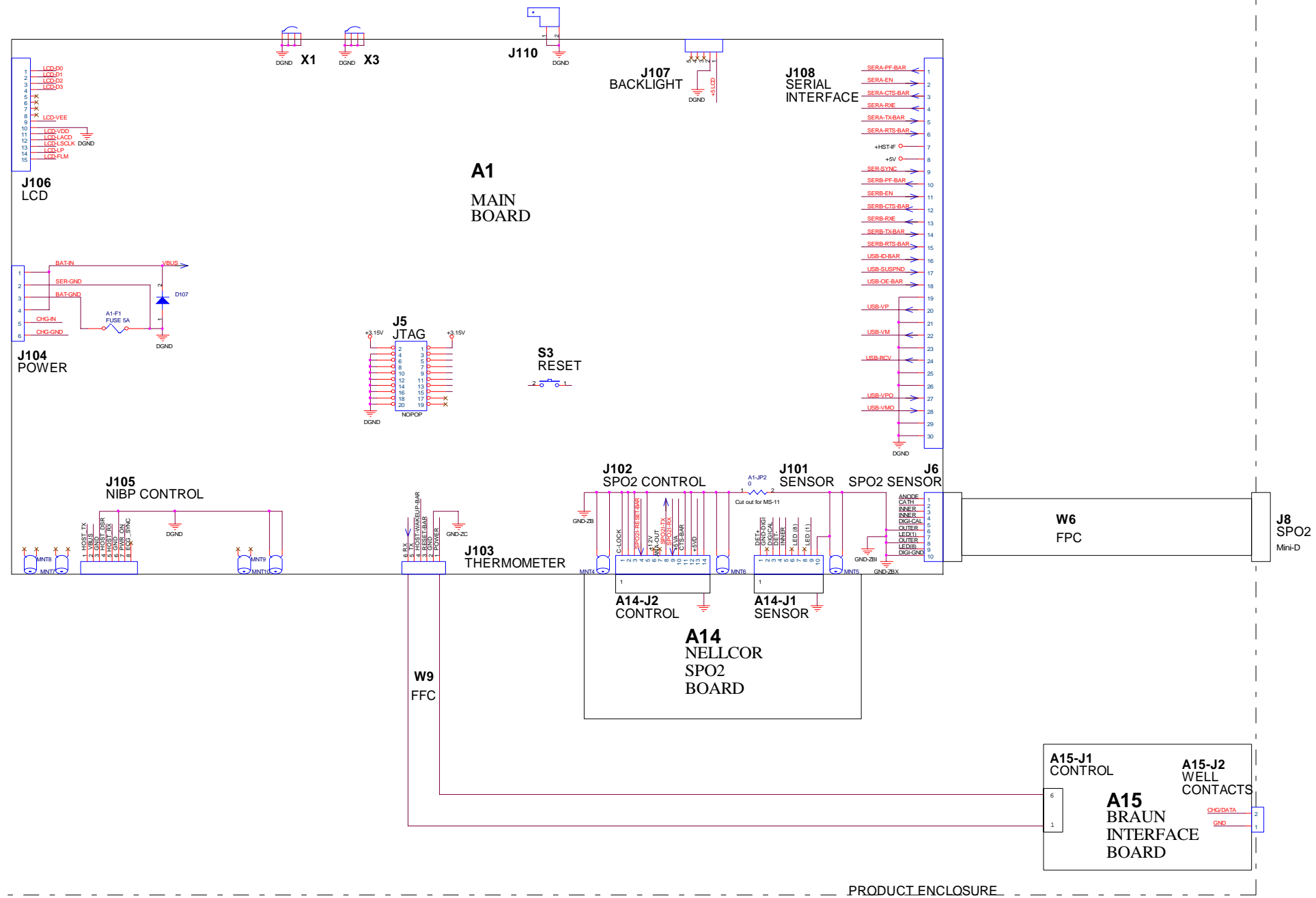

Note: This page depicts interconnect for Nellcor SPO2 and Braun Thermometer options only.

THIS INFORMATION IS THE PROPERTY OF WELCH ALLYN. IT IS SUBMITTED IN CONFIDENCE AND IS NOT TO BE DISCLOSED OR UTILIZED WITHOUT WRITTEN PERMISSION.	APPROVALS	DATE	WELCH ALLYN	
	CHECK		TITLE	
	PROJ. MGR.		Spot Lxi Interconnect Diagram	
	Source document: 40700-HDD		SIZE B	NUMBER
PCB Mat# (ref)		DATE 12/6/05	SHEET 2 of 2	
PCA Mat# (ref)			DRAWN BY K Burdick	

# 5

## Maintenance and Service

---

### Cleaning



**WARNING** Before performing any maintenance or service to the Spot Vital Signs LXi, disconnect the AC power line from the electrical outlet.

### Spot Vital Signs LXi



**Caution** Prevent water or other fluids from entering any connectors. If the connectors get wet, dry them with warm air. Check all measurement functions.

**Caution** Do not sterilize or autoclave the Spot Vital Signs LXi device.

As necessary, clean the device with a cloth slightly dampened with either 70% isopropyl alcohol, 10% chlorine bleach solution, or mild detergent in water, or use PDI Sani-System Cloths. Never immerse Spot Vital Signs LXi in any type of fluid.

### Blood Pressure Cuff

Before washing the Reusable Two-Piece Cuff, remove the two connectors and bladder, close off tubes with plugs (available as accessory 5082-163), and close the hook and loop fasteners. After washing, allow the cuff to air dry. Re-assemble the tube fittings.

Never press with an iron.

### Blood Pressure Hose and Cable

Wipe the pressure hose with a damp cloth moistened in a mild detergent solution. Do not immerse hose.

## SureTemp Plus Thermometer

### Temperature Probe



**Caution** DO NOT immerse or soak the probe in any type of fluid.

**Caution** DO NOT use steam, heat, or gas sterilization on the probe.

**Caution** DO NOT autoclave the probe.

Press down on the connector tab and slide the connector out of the port to remove the temperature probe.

Regularly wipe the probe with a cloth dampened with warm water and a mild detergent solution, a 70% isopropyl alcohol solution, or a 10% chlorine bleach solution.

### Removable Probe Well



**Caution** DO NOT use hard or sharp objects to clean the probe well. This could damage the probe well and cause the device to not function properly.

**Caution** DO NOT use steam, heat, or gas sterilization on the probe well.

**Caution** DO NOT autoclave the probe well.

1. Remove the temperature probe from Spot Vital Signs LXi (see “Temperature Probe” on page 44).
2. Grasp the well under the probe opening and pull up gently to remove it from the device.
3. Swab the inner and outer surface of the probe well with a cloth dampened with a mild detergent solution, 70% isopropyl alcohol, or 10% chlorine bleach solution. Immerse the probe well in mild detergent solution as necessary for cleaning.
4. Dry all surfaces thoroughly before re-assembling the device (see “SureTemp Plus” on page 26) for reassembly instructions.

## Braun ThermoScan PRO 4000 Thermometer

Use a soft cloth slightly moistened with alcohol to clean the thermometer display and exterior. Do not use abrasive cleaners.

Damage to the probe window or the presence of dirt or cerumen on the probe window can affect the accuracy of your temperature measurement. To clean the window, gently wipe it with a cotton swab slightly moistened with alcohol and immediately wipe dry with a clean cotton swab. Allow to dry at least five minutes before taking a temperature.

Every month, clean the Braun ThermoScan PRO 4000 charging contacts within the Spot Vital Signs LXi housing with a swab slightly dampened with alcohol.

## SpO<sub>2</sub> Sensors



**WARNING** Do not immerse the sensor in water, solvents, or cleaning solutions (the sensors and connections are not waterproof). Do not use irradiation, steam, or ethylene oxide for sterilization.

Clean the reusable SpO<sub>2</sub> sensor with a 70% isopropyl alcohol solution. Do not immerse the sensor.

## Radio

Refer to Manufacturer's Directions for Use.

## Printer

The printer label kit comes with a two-step head cleaner. Follow the directions provided with the cleaner.

# Battery Replacement

## Spot Vital Signs LXi



**Caution** Only use the Welch Allyn 4500-84 lead acid battery. Using an incorrect battery will cause damage to the Spot Vital Signs LXi and void the warranty.

**Caution** Do not break the shrinkwrap around the battery.

If necessary, replace the internal battery after heavy use or the battery no longer charges.

1. Power off the Spot Vital Signs LXi and disconnect the AC power transformer cord.
2. Remove the four screws holding the battery door using a phillips-head screwdriver. Remove the battery door to expose the battery.
3. Tip the Spot Vital Signs LXi backward and slide the battery out. Disconnect the one-way connector and then attach a new battery to the connector as shown. The one-way connector ends only connect one way. Do this as quickly as possible to prevent loss of clock time.

**Figure 1. Battery Removal and One-way Connector**

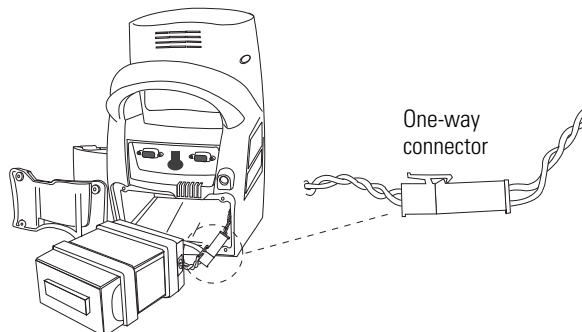

4. Slide the battery into the compartment as far as it will go. Push the connector down into the case next to the battery.
5. Replace the battery door and tighten each of the four screws.
6. Connect the AC power transformer to the Spot Vital Signs LXi and allow the new battery to charge for approximately 6 hours. The rechargeable batteries in the Braun ThermoScan PRO 4000 thermometer requires an additional 1 hour to charge and the rechargeable batteries in the external printer require an additional 4 hours to charge. You can use the Spot Vital Signs LXi during this charging period via the AC power cord.

If Spot Vital Signs LXi displays the E38 error code after power up, set the date (see "Date/Time Menu Options" on page 31).



The battery is a non-spillable lead-acid battery and must be recycled or disposed of properly according to national or local regulations.



## Braun ThermoScan PRO 4000



**Caution** Do not use alkaline batteries in the Braun ThermoScan PRO 4000 thermometer.

Welch Allyn supplies a rechargeable battery pack with the Braun ThermoScan PRO 4000 thermometer.

1. Open the battery compartment.
2. Remove the battery pack and replace with a new battery pack, verify the poles are in the right direction.
3. Slide the battery door back in until it snaps into place.

If the battery is completely discharged, the LEDs will not illuminate. Allow the unit to charge at least 15 minutes before proceeding.



The battery is a rechargeable battery and must be recycled or disposed of properly according to national or local regulations.

## Printer



**Caution** Do not use alkaline batteries in the printer.

1. Open the battery compartment.
2. Remove the battery pack and replace with a new battery pack, verify the poles are in the right direction.
3. Slide the battery door back in until it snaps into place.

Allow the printer to charge at least 15 minutes before proceeding.



The battery is a rechargeable battery and must be recycled or disposed of properly according to national or local regulations.

## Spot Vital Signs LXi Firmware Upgrade CD

This CD upgrades the Spot Vital Signs LXi unit software version. A detailed procedure is available on the upgrade CD.

## Spot Vital Signs LXi Radio Configuration CD

This CD configures the Spot Vital Signs LXi Radio to a local network. This feature requires Welch Allyn Connex Version 2.0 or higher (not available in all countries). For more information about Connex, see [www.welchallyn.com](http://www.welchallyn.com).

## Product Disposal

Do not dispose of this product as unsorted municipal waste. Prepare this product for reuse or separate collection as specified by Directive 2002/96/EC of the European Parliament and the Council of the European Union on Waste Electronic and Electrical Equipment (WEEE). If this product is contaminated, this directive does not apply.

For more specific disposal information, see [www.welchallyn.com/weee](http://www.welchallyn.com/weee), or contact Welch Allyn Customer Service at +44 207 365 6780.

# 6

## Calibration and Verification

---

### Terms

**BP test volume repair fixture.** Equipment with four separate volume cylinders: 100cc, 200cc, 250cc, and 500cc. Referred to in this procedure as Test Volume.

**Calibration.** Process to change the outputs of the UUT that are out of range. After saving, the changes become permanent until the next calibration.

**Pneumatic test assembly.** Equipment that connects the UUT, the pressure meter, the squeeze bulb, and the BP test volume repair fixture.

**Repair software.** Software package to verify and calibrate the Spot LXi device.

**Service computer.** Computer with the repair software loaded and ready to operate.

**Tests.** Process to check the outputs of the UUT.

**UUT.** Unit under test.

# Pneumatic test assembly setup

## Equipment:

**Note** See "Tool list" on page 101 for equipment part numbers.

- Square fitting connector
- Calibrated pressure meter
- UUT
- BP test volume repair fixture. Must have at least the following volume cylinders: 100cc, 250cc, and 500cc
- Squeeze bulb with bleeding screw
- Power supply, 0-10 volts, 2 amps capacity or better
- Two-tube blood pressure hose with "Y" fitting
- 12-inch (30.5 cm) tubing with .25-inch (6.35 mm) ID - quantity 4

1. Connect a piece of tubing to the squeeze bulb with bleeding screw and the opposite end to the square fitting connector.
2. Connect another piece of tubing to the square fitting connector and the opposite end to the calibrated pressure meter.
3. Connect another piece of tubing to the square fitting connector and the opposite end to the test volume.
4. Connect the last piece of tubing to the square fitting connector and the opposite end to the "Y" fitting on the two-tube blood pressure.

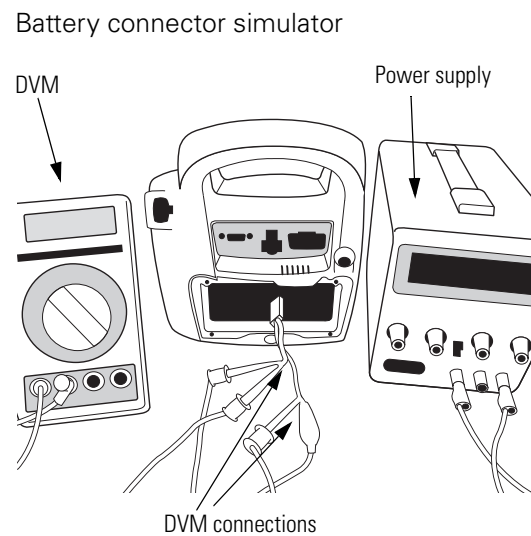
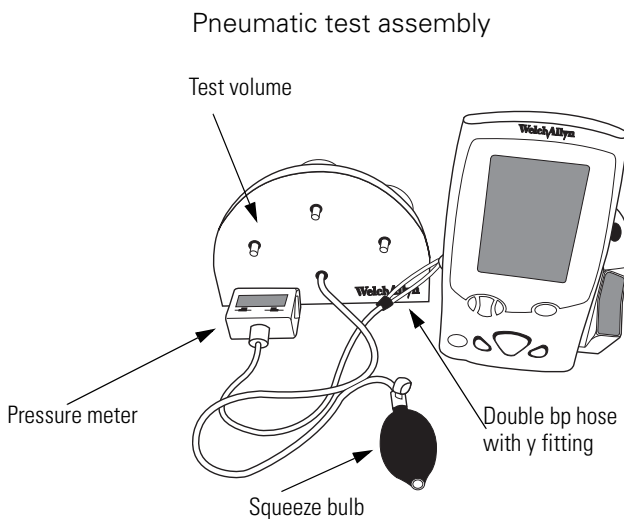

# Voltage Calibration

## Equipment:

**Note** See "Tool list" on page 101 for equipment part numbers.

- UUT
- Digital voltage meter
- Power supply, 0 to 10 volts, 2 amps capacity or better
- Battery connector simulator

1. Disconnect battery and connect power supply to UUT, observing correct polarity. Connect DVM to power supply leads at the battery simulator.
2. Set the power supply to 6.5 VDC.
3. Power on UUT in configuration mode (press the check button and power on the UUT). Hold check button until the UUT beeps twice.
4. Adjust the power supply to 5.5 +/- 0.1 VDC at battery connector simulator leads.
5. Select **Calibrate > Voltage** on the service computer. The UUT LCD goes blank.
6. Read the voltage on the DMM connected to the battery simulator leads.
7. Enter this voltage reading into the **Actual Voltage** field and click **Calibration** button.
8. Click the **OK** button to accept the inputs. Click **Yes** to make the changes permanent.
9. Enter your initials in the **Calibration Signature Field** and click OK. **UUT** resets and powers up in normal mode.

## Pressure verification test

**Note** If this is a new NIBP board, go to “[Blood pressure calibration](#)” on page 54 and carefully follow the instructions to initialize this board.

Any UUT in the field for a year or longer is due for calibration. See “[Blood pressure calibration](#)” on page 54 . Otherwise continue in this section.

### Equipment:

**Note** See “[Tool list](#)” on page 101 for equipment part numbers.

- Pneumatic test assembly (see “[Pneumatic test assembly setup](#)” on page 50)
- Standard blood pressure cuff, size 11 (adult) preferred
- Digital voltage meter
- Power supply, 0 to 10 volts, 2 amps capacity or better
- Battery connector simulator
- UUT

1. Disconnect battery and connect the battery simulator and the power supply to the UUT, observing correct polarity.
2. Connect the DVM to the power supply leads at the battery simulator and set the power supply to 6.5 volts dc. Measure voltage where the power supply leads connect to the battery connector simulator leads.
3. Connect UUT to the pneumatic test assembly. Connect the test volume hose to the 500 cc cylinder.
4. Power on UUT in configuration mode (press the check button and power on the UUT). Hold check button until the UUT beeps twice. The configuration screen displays, scroll to **Blood Pressure** and select it. Select **BP Calibration Check**.
5. Open the repair software and select **Test > Calibration**. A **Test Calibration** box displays on the screen.
6. Verify the pressure is at or near zero and the voltage is within 0.1 VDC of the power supply (6.5 v dc). Verify the valve status is open and the pump status is off.
7. Select **Close Valve** on the UUT. The valve status changes to closed.
8. Select the **Start Cuff Inflation**. The pump starts inflating the cuff. Verify the pump status is on and the pressure is rising.
9. Inflate the pressure up to 250 mmHg. Select the **Stop Pump** on the UUT to stop the inflation. Fine tune the pressure reading to 250 mmHg with the squeeze bulb.
10. Check the reading on the pressure meter against reading on the UUT.
  - a. Verify the pressure on the UUT is within the pressure tolerance in the table. Use the squeeze bulb to fine tune the pressure at each inflation pressure limit. If the pressure is within tolerance, go to the next inflation pressure.

#### Inflation pressure Pressure tolerance

250 mmHg +/- 2 mmHg  
150 mmHg +/- 1.5 mmHg

#### Inflation pressure Pressure tolerance

50 mmHg +/- 1 mmHg  
0 mmHg +/- 1 mmHg

- b. If the UUT is not within the pressure tolerance, open the valve to bleed pressure to zero. Select **Calibrate > Pressure** on the repair software. Proceed to [“Blood pressure calibration”](#). UUT needs calibration.
11. If all readings are within specification, go to [“Functional tests” on page 56](#).

# Blood pressure calibration

**Note** This section updates the pressure calibration of the UUT.

If all readings were within specifications during [“Pressure verification test”](#) on page 52, skip this section and go to [“Functional tests”](#) on page 56.

## Equipment:

**Note** See [“Tool list”](#) on page 101 for equipment part numbers.

- Pneumatic test assembly (see [“Pneumatic test assembly setup”](#) on page 50)
- Standard blood pressure cuff, size 11 (adult) preferred
- Power supply, 0 to 10 volts, 2 amps capacity or better
- Digital voltage meter
- Battery connector simulator
- UUT

## To initialize the NIBP board:

1. Open repair tool (Ver 3.0 or greater) and click **Calibrate > Reset Defaults**. The Reset Defaults window displays.
2. Click **Reset > Initialize > OK**. The NIBP board is initialized. Perform the blood pressure calibration section.

## To perform the blood pressure calibration

1. Disconnect battery, connect the power supply, and set to 6.5 volts dc. Otherwise leave power supply as it is from [“Pressure verification test”](#) on page 52.
2. On the service computer select **Calibrate > Pressure**.
3. Power on UUT in configuration mode (press the check button and power on the UUT). Hold check button until the UUT beeps twice. The configuration screen displays, scroll to **Blood Pressure** and select it. Select **BP Calibration Check**.
4. Connect the hose to the 500cc cylinder of the test volume and verify the following:
  - the pressure is at zero mmHg,
  - the bleed screw on squeeze bulb is closed,
  - valve on UUT is in the open state.
5. On the computer screen select **Calibrate Zero button**.
6. Press the NIBP button to close valve on UUT and use the squeeze bulb to manually inflate the UUT to 200 mmHg. Let stabilize. Enter the pressure meter reading in the **Calibration Gain Field** on the service computer. Be as precise as possible. If pressure meter has resolution of 1 mmHg make sure it reads 200 without switching to 199 or 201. Enter 200.00 in **Calibration Gain Field**.
7. Click **Calibrate Gain** on the service computer.
8. Click **OK** to accept the inputs. Click **Yes** to make the changes permanent.



9. Enter your initials in the **Calibration Signature Field** and click **OK**. UUT resets and powers up in normal mode.
10. Blood Pressure calibration is complete.

# Functional tests

**Note** Perform the tests sequentially.

Each test is software driven. Selecting the **Test** button begins the test.

Connect and verify the correct cylinder (in parenthesis) or the test will fail.

Select **Configuration** to see a preferred connections diagram for each test.

## Equipment:

- Pneumatic test assembly (see “Pneumatic test assembly setup” on page 50)
- Standard blood pressure cuff, size 11 (adult) preferred
- Power supply, 0 to 10 volts, 2 amps capacity or better
- Digital voltage meter
- Battery connector simulator
- UUT

## Test specifications:

- Leak test** 6mm maximum in 15 seconds with a volume of 100 cc at 250 mmHg
- Dump test** From 260 to less than 15 mmHg in 10 seconds or less with a volume of 500 cc
- Inflation test** From 5 to 210 mmHg in 7 seconds or less with a volume of 250 cc
- Valve control test** From 160 mmHg with a volume of 100 cc  
Open the valve for the following amounts of time and pressure drop:
- 10 msec = 4 to 12 mmHg
  - 15 msec = 4 to 15 mmHg
  - 25 msec = 4 to 25 mmHg
- Inflation linearity** Connect a standard size cuff to the UUT and inflate.  
Measure the pressure at 6, 9, and 12 seconds and compare to the expected readings at these intervals.  
Also check the noise level at 7, 10, and 13 seconds into the inflation step.

## To perform the functional tests:

1. Close the **Pneumatics** test box and open the **Current Levels** test box. Perform the tests listed.
  - a. Sleep state mode: LCD is off and the UUT is idle. Verify the current is approximately 200 mA.
  - b. Valve/pump mode: UUT is fully active with the valve closed and the pump running. The UUT can draw up to 2.0 amperes in this state.
  - c. Normal mode: LCD is lit, but the UUT is inactive. The UUT current draw is approximately 700 to 800 mA.
2. Close the **Test Current Levels** box and open the **Test Noise Levels** box. The Test Noise Levels test measures the amount of noise on the UUT A-D pressure channel. The sample is 1 second in length with 0 mmHg applied. The maximum allowed noise is .050 mmHg.
3. Close the **Test Noise Levels** box and open the **Buttons Test** box.

4. Press each button on the UUT and verify the appropriate button lights on the service computer.
5. When finished close the **Buttons Test** box and open the **Interface** box.
6. Perform all commands in this test, verifying the LCD on the UUT responds correctly with each command.

**To perform the over pressure test:**

1. Verify the UUT is in normal mode and remove the blood pressure cuff.
2. Re-install the pneumatic test assembly with the 250 cc cylinder connected.
3. Go to the repair software select **Unit >Status**. A **Unit Status** box displays.
4. Check the **Log Status Information** box in the lower right hand corner of the computer screen. Event logs display in rapid succession.
5. Immediately initiate a blood pressure reading. As the pressure increases, start applying additional pressure with the squeeze bulb.
6. Increase the pressure to the UUT until an E10 error displays.
7. Uncheck the **Log Status Information** box and close the **Unit Status** box.
8. Scroll through the event log to locate the last 'no' answer, directly followed by the first 'yes' answer in the column labeled over pressure.
9. Scroll to the right to see the mmHg pressure that these events occurred.
10. Select the higher pressure reading when the E10 error occurred. Verify the pressure is between 296 and 329 mmHg.

**Note** The following tests are for verification only. There is no updating of calibration parameters. If any function fails accuracy standards, replace the part.

# Temperature Functional Check

The 9600 Plus Calibration Tester takes approximately 20 minutes to heat to the lowest setting. When testing several thermometers at all three temperatures, it is recommended to test all probes at one Calibration Set Point Temperature before proceeding to the next Calibration Set Point Temperature.

To further expedite testing start at the lowest Calibration Set Point Temperature. The 9600 Plus Calibration Tester does not have an internal fan, this causes a longer cool down time than warm up time.

Refer to the 9600 Plus Calibration Tester Directions for Use manual for specific information regarding the LCD window or the control buttons.

1. Choose the proper mains plug insert and slide it over the two prongs in the power converter.

**Figure 1. Power Adapter and Mains Plug Inserts**

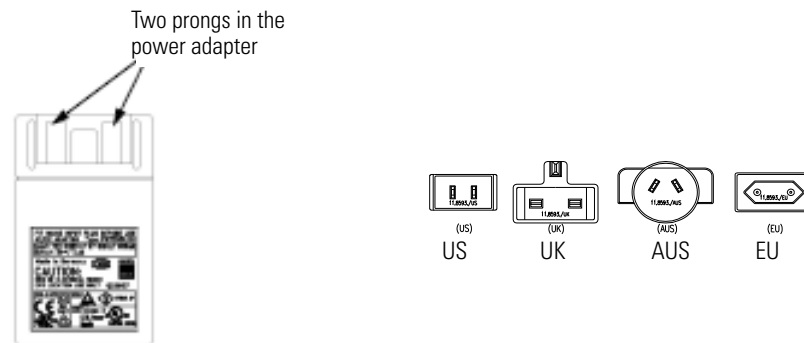

2. Plug the power adapter into the 9600 Plus Calibration Tester ([Figure 1](#)) and the opposite end into a wall outlet.
3. Place the 9600 Plus Calibration Tester on a level surface away from sunlight, drafts, and other sources of heat or cold.
4. Observe the Set Point Mode in the upper left hand corner of the LCD display. If the unit displays a "D", it is in Default Mode and will heat to the lowest Set Point Temperature. If you do not want to conduct testing at this Set Point Temperature, press and hold the Temperature Selection button to select the desired setting. The temperature display will flash before staying on continuously to indicate the 9600 Plus Calibration Tester has stabilized and is ready for use.

## Welch Allyn SureTemp Plus Thermometers



**Caution** Store thermometers for testing in the same room as the 9600 Plus Calibration Tester for approximately 30 minutes prior to testing to allow for thermal accommodation.

### To begin functional verification of the SureTemp Plus thermometer:

1. Remove the probe from the probe well and clean it with either a 70% isopropyl alcohol solution, a 10% chlorine bleach solution, or a non-staining disinfectant. Let the probe air dry. Do not apply a probe cover.
2. Place the thermometer in Monitor Mode, refer to the thermometer's Operator's Manual.
3. Insert the probe into the Thermistor Device Port.

**Figure 2. 9600 Plus Calibration Tester with the Welch Allyn SureTemp Plus Thermometer**

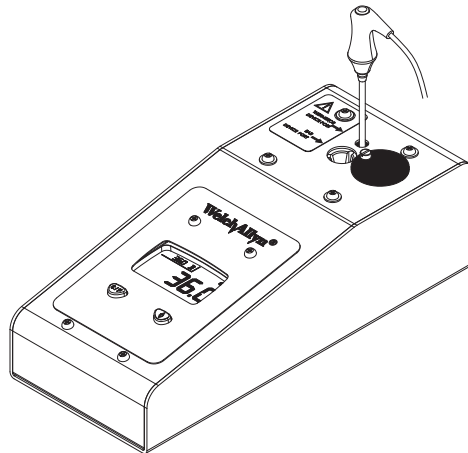

4. Wait for approximately one minute or until temperature on the thermometer is stable for ten seconds. Compare the thermometer's temperature reading to the 9600 Plus Calibration Set Point Temperature. If the temperatures are within  $\pm 0.1^{\circ}\text{C}$  ( $\pm 0.2^{\circ}\text{F}$ ), the thermometer is within calibration.
5. Test all available thermometers for calibration verification at the current Calibration Set Point Temperature. Proceed to the next Calibration Set Point Temperature, see "Changing the Calibration Set Point Temperature" on page 61.

## Braun ThermoScan Pro 4000



**Caution** Store thermometers for testing in the same room as the 9600 Plus Calibration Tester for approximately 30 minutes prior to testing to allow for thermal accommodation.

### To begin functional verification of the Braun ThermoScan PRO 4000 thermometer:

1. Clean the probe tip with a cotton swab slightly moistened with isopropyl alcohol, remove excess alcohol with a clean cotton swab, and let air dry for 5 minutes. Do not use any chemical other than alcohol to clean the probe window.
2. Place the Braun ThermoScan Pro 4000 in Calibration Mode using the following steps:
  - a. Push and release the I/O MEM button to turn the product on. The display shows symbols and functions. The Braun ThermoScan Pro 4000 performs an automatic self check. After a few seconds you hear a beep and see three dashed lines, a sound symbol, and ° C or ° F on the display.
  - b. Push the I/O MEM button again and keep it pressed for the following steps:
    - After approx. 3 seconds the "OFF" symbol flashes on the display (keep pressing the button).
    - When you hear a beep, release the button immediately.
    - The Braun ThermoScan Pro 4000 is now in calibration check mode and the display is flashing and showing the "CAL" symbol.
3. Apply a new probe cover. Place the probe firmly into the Ear Device Port.

**Figure 3. 9600 Plus Calibration Tester with the Braun ThermoScan Pro 4000**

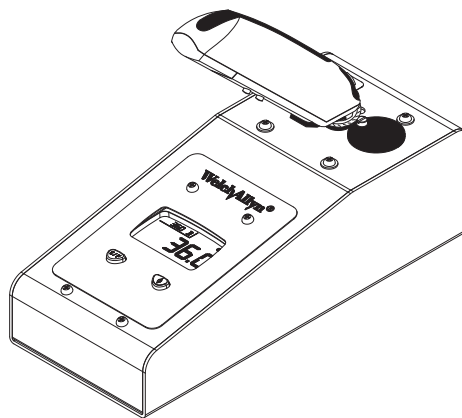

4. Wait approximately three seconds, press the thermometer Start button, and watch for the "Exac Temp" light to flash.
5. Leave the thermometer in the 9600 Plus Calibration Tester until you hear a beep.
6. Remove the Pro 4000 Thermometer from the 9600 Plus Calibration Tester and read the temperature in the thermometer's display. If the temperatures are within  $\pm 0.1^{\circ}\text{C}$  ( $\pm 0.2^{\circ}\text{F}$ ), the thermometer is within calibration.

7. Wait one full minute before taking another reading with the same thermometer. Repeated measurements in short sequence may cause higher readings.
8. The device will exit CAL mode after four minutes.
9. Test all available thermometers for calibration verification at the current Calibration Set Point Temperature. Proceed to the next Calibration Set Point Temperature, see [“Changing the Calibration Set Point Temperature”](#).

## Changing the Calibration Set Point Temperature

To scroll from one set point to the next, press and hold the Temperature Selection button until a beep is heard. The newly selected set point appears in the upper left corner of the LCD display. The device's current temperature is displayed, starts to flash, and continues flashing until the cavity reaches the equilibrium at the new set point.

## Masimo SpO2 Functional Check

Use the Masimo Tester to perform to functionally check the Masimo sensors.

1. Orient the Masimo Tester such that the mini-D connector mates with the SpO2 connector on Spot Vital Signs LXi.
2. Power on Spot Vital Signs LXi and confirm the SpO2 reading in the Display Window is  $81\% \pm 3\%$  and the pulse reading is  $61 \text{ bpm} \pm 1 \text{ bpm}$ .
3. Place the thumb and index finger on the gray buttons on either side of the Masimo Tester connector, press the buttons firmly, and gently pull to remove the tester.

There is no way to change the functionality of the SpO2 module. If the SpO2 is out of calibration, contact Technical Service.

## Nellcor SpO2 Functional Check

Use a Nellcor-approved SpO2 simulator (SRC-MAX ) to check the SpO2 functionality.

1. Orient the simulator such that the connector mates with the SpO2 connector on Spot Vital Signs LXi.
2. Power on Spot Vital Signs LXi and confirm the SpO2 reading in the Display Window is  $90\% \pm 1\%$  and the pulse reading is  $60 \text{ bpm} \pm 1 \text{ bpm}$ .
3. Place the thumb and index finger on either side of the simulator connector, press the buttons firmly, and gently pull to remove the simulator.

There is no way to change the functionality of the SpO2 module. If the SpO2 is not functioning properly, contact Technical Service.





# 7 Specifications

## Performance

This section describes normal ranges for Spot Vital Signs LXi.

### Blood Pressure Accuracy

Blood pressure accuracy meets or exceeds AAMI SP10:2002 standards for non-invasive blood pressure accuracy ( $\pm 5$  mmHg mean error, 8 mmHg standard deviation). Blood pressure accuracy is validated for pressure measurement using the upper arm only.

<b>Cuff Pressure Range</b>	0 to 300 mmHg
<b>Systolic Range</b>	60 to 250 mmHg
<b>Diastolic Range</b>	30 to 160 mmHg
<b>Blood Pressure Determination Time</b>	Typical: 15 seconds
<b>Mean Arterial Pressure Range</b>	40 to 190 mmHg
<b>Pulse Rate Range (using SpO<sub>2</sub> determination)</b>	25 to 240 bpm
<b>Pulse Rate Range (using Blood Pressure determination)</b>	35 to 199 bpm
<b>Pulse Rate Accuracy (using SpO<sub>2</sub> determination)</b>	Without Motion: 25 to 245 bpm $\pm 3$ digits <sup>1</sup> With Motion: normal physiologic range (55 to 125 bpm) $\pm 5$ digits <sup>1</sup> Low Perfusion: 25 to 245 bpm $\pm 3$ digits <sup>1</sup>
<b>Pulse Rate Accuracy (using Blood Pressure determination)</b>	$\pm 5.0\%$
<b>Overpressure Cutoff</b>	315 mmHg $\pm 15$ mmHg

<sup>1</sup> Specification applies to device performance and was validated with Biotek and Nellcor simulators.

## Temperature Specifications

**Temperature Range**

SureTemp Plus	80° to 110° F (26.7° to 43.3° C)
Braun ThermoScan PRO 4000	68° to 108° F (20° to 42.2° C)

**Calibration Accuracy**

SureTemp Plus	±0.2° F (0.1° C) (Monitor Mode)
Braun ThermoScan PRO 4000 for displayed temperature ranges	± 0.4° F (±0.2° C) 95.9° to 107.6° F (35.5° to 42° C) ±0.5° F (±0.25° C) (outside this temperature range)

**Display Resolution**

0.1° F or ° C

**SureTemp Plus Predict Time**

Oral	Approx. 4 to 6 seconds
Adult Axillary	Approx. 12 to 15 seconds (age 18 years and older)
Pediatric Axillary	Approx. 10 to 13 seconds (age 17 years and younger)
Rectal	Approx. 10 to 13 seconds

# SpO<sub>2</sub> Specifications

## Masimo Sensor Accuracy Guide

Accuracy specified when used with Masimo SET pulse oximetry monitors or with licensed Masimo SET pulse oximetry modules using PC series patient cables, during no motion. Numbers present  $\pm 1$  standard deviation. Plus or minus one standard deviation represents 68% of the population. SpO<sub>2</sub> accuracy from 70% to 100%. Pulse rate accuracy from 25 to 240 bpm.

<b>Performance Measurement Range</b>	SpO <sub>2</sub> : 1 to 100% Pulse Rate: 25 - 240 beats per minute (BPM)
<b>Perfusion</b>	0.02% to 20%
<b>Accuracy</b>	Saturation: 70% to 100% No Motion: Adults, Pediatrics $\pm 2$ digits Neonates $\pm 3$ digits  Motion: Adults, Pediatrics $\pm 3$ digits Neonates $\pm 3$ digits  Low Perfusion: Adults, Pediatrics $\pm 2$ digits Neonates $\pm 3$ digits
<b>Pulse Rate Accuracy</b>	Pulse Rate: 25 to 250 bpm  No Motion: Adults, Pediatrics, Neonates $\pm 3$ digits  Motion: Adults, Pediatrics, Neonates $\pm 5$ digits  Low Perfusion: Adults, Pediatrics, Neonates $\pm 5$ digits

**Table 1. Masimo Sensor Accuracy Guide**

Sensor	Weight Range	Saturation Accuracy		Pulse Rate Accuracy	
		No Motion	Motion	No Motion	Motion
LNOP-ADT	> 30 kg	$\pm 2\%$	$\pm 3\%$	$\pm 3$ bpm	$\pm 5$ bpm
LNOP-PDT	10 to 50 kg	$\pm 2\%$	$\pm 3\%$	$\pm 3$ bpm	$\pm 5$ bpm
LNOP-NEO	< 10 kg	$\pm 3\%$	$\pm 3\%$	$\pm 3$ bpm	$\pm 5$ bpm
LNOP-NEOPT	< 1 kg	$\pm 3\%$	$\pm 3\%$	$\pm 3$ bpm	$\pm 5$ bpm
LNOP-DCI	> 30 kg	$\pm 2\%$	$\pm 3\%$	$\pm 3$ bpm	$\pm 5$ bpm
LNOP-DCIP	10 to 50 kg	$\pm 2\%$	$\pm 3\%$	$\pm 3$ bpm	$\pm 5$ bpm

## Masimo Patents

The Masimo sensors and cables are covered under one or more of the following U.S.A. patents: 5,758,644; 5,823,950; 6,011,986; 6,157,850; 6,263,222; 6,501,975; and other applicable patents listed at [www.masimo.com/patents.htm](http://www.masimo.com/patents.htm).

## Nellcor Sensor Accuracy Guide

Accuracy specifications are based on controlled hypoxia studies with healthy, non-smoking adult volunteers over the specified saturation SpO<sub>2</sub> range. Pulse oximeter SpO<sub>2</sub> readings were compared to SaO<sub>2</sub> values of drawn blood samples measured by hemoximetry. All accuracies are expressed as  $\pm$  "X" digits. This variation equals  $\pm$  one standard deviation ( $\pm$  1 SD), which encompasses 68% of the population.

**Table 2. OxiMax Sensor Models, Single Patient Use**

Sensor Models	SpO <sub>2</sub> Range 70% to 100%
MAX-AI <sup>1</sup>	$\pm$ 2
MAX-PI*	$\pm$ 2
MAX-II	$\pm$ 2
MAX-RI <sup>2</sup>	$\pm$ 3.5

<sup>1</sup> The accuracy specification under motion conditions is  $\pm$  3. For a definition of motion, contact Nellcor Technical Services or your local Nellcor representative.

<sup>2</sup> The accuracy specification has been determined between saturations of 80% to 100%.

**Table 3. OxiCliq Sensor Models, Single Patient Use**

Sensor Models	SpO <sub>2</sub> Range 70% to 100%
OXICLIQ-PI	$\pm$ 2.5

**Table 4. Reusable Sensor Models**

Sensor Models	SpO <sub>2</sub> Range 70% to 100%
D-YS (Infant to Adult)	$\pm$ 3
D-YS and D-YSE	$\pm$ 3.5
D-YS and D-YSPD	$\pm$ 3.5
DS-100A	$\pm$ 3
OXI-A/N (Adult/neonate)	Adult: $\pm$ 3 Neonate: $\pm$ 4
OXI-P/I (Pediatric/infant)	$\pm$ 3

## Nellcor Patents

Covered by one or more of the following US Patents: 4,802,486; 4,869,254; 4,928,692; 4,934,372; 5,078,136; 5,351,685; 5,485,847; 5,533,507; 5,577,500; 5,803,910; 5,853,364; 5,865,736; 6,083,172; 6,708,049; Re. 35,122 and foreign equivalents.

## Mechanical

<b>Dimensions</b>	Height: 10.63" (27 cm) Length/Braun: 8" (20.32 cm) Length/SureTemp Plus: 7.5" (19 cm) Depth: 5.25" (13.34 cm)
<b>Weight</b>	7.5 lbs (3.4 kg)
<b>Mounting</b>	Self-supporting on rubber feet Custom mobile stand Custom wall mount
<b>Portability</b>	May be hand-carried when held by the rear handle

## Electrical

<b>Power Requirements</b>	Patient-rated isolation transformer is connected to AC mains: 100-240V, 50-60Hz, 0.4A or internal power: 6Vdc, 6Ah
---------------------------	---

## Patents

6,827,488; 6,971,790; and other patents pending.

## Battery

Sealed lead acid, with external charger.

The Spot Vital Signs LXi battery is 90 to 100% charged after 6 hours of charging. The rechargeable batteries in the Braun ThermoScan PRO 4000 thermometer requires an additional 1 hour to charge and the rechargeable batteries in the external printer require an additional 4 hours to charge. The battery automatically charges when Spot Vital Signs LXi is powered through the AC power transformer. An operator can use the device while the battery is charging; however, the battery charges faster when the instrument is not in operation.

## Environmental



**WARNING** This device is not suitable for use in the presence of a flammable anesthetic mixture with air or oxygen or nitrous oxide. An explosion may result.

<b>Operating Temperature</b>	50° to 104° F (10° to 40° C)
<b>Storage/Transport Temperature</b>	Device with SureTemp Plus: -13° to 131°F (-25° to 55°C) Device with Braun ThermoScan PRO 4000: -4° to 122°F (-20° to 50°C)
<b>Relative Humidity</b>	15 to 95% (non-condensing)
<b>Operating Altitude</b>	-557 to 16,000 ft. (-170 to 4877 m)

## Radio

Refer to the manufacturer's Direction for Use.

## Mechanical

<b>Dimensions</b>	3.93" L x 2.38" W x 1.42" T 99.78mm L x 60.5 mm W x 36.1mm T
<b>Mounting</b>	Nylon Bracket
<b>Operating Temperature</b>	-40° C to +85° C
<b>Storage Temperature</b>	-40° C to +125° C

## Configuration Options

<b>DHCP Enabled or Not</b>	If not DHCP: <ul style="list-style-type: none"><li>• IP Address</li><li>• Subnet Address</li><li>• Gateway</li></ul>
<b>Encryption</b>	<ul style="list-style-type: none"><li>• WEP</li><li>• WPA</li></ul>
<b>WPA Pass Phrase</b>	Channel
<b>WEP Key 1-4</b>	Default WEP Key
<b>SSID</b>	WEP Authentication

# Guidance and Manufacturer's Declaration For Spot Vital Signs LXi Radio

## Emissions and Immunity Information

### Electromagnetic Emissions

The Spot Vital Signs LXi is intended for use in the electromagnetic environment specified below. The customer or user of the Spot Vital Signs LXi should assure that it is used in such an environment.

Emissions Test	Compliance	Electromagnetic Environment - Guidance
RF emissions CISPR 11	Group 1	The Spot Vital Signs LXi uses RF energy only for its internal function. Therefore, its RF emissions are very low and are not likely to cause any interference in nearby electronic equipment.
RF emissions CISPR 11	Class B	The Spot Vital Signs LXi is suitable for use in all establishments, including domestic establishments and those directly connected to the public low-voltage power supply network that supplies buildings used for domestic purposes.
Harmonic emissions IEC 61000-3-2	Class A	
Voltage fluctuations/ flicker emissions IEC 61000-3-3	Complies	

### Electromagnetic Immunity

The Spot Vital Signs LXi is intended for use in the electromagnetic environment specified below. The customer or user of the Spot Vital Signs LXi should assure that it is used in such an environment.

Immunity Test	IEC 60601 Test Level	Compliance Level	Electromagnetic Environment - Guidance
Electrostatic discharge (ESD) IEC 61000-4-2	± 6 kV contact ± 8 kV air	± 6 kV contact ± 8 kV air	Floors should be wood, concrete, or ceramic tile. If floors are covered with synthetic material, the relative humidity should be at least 30%.
Electrical fast transient/ burst IEC 61000-4-4	±2 kV for power supply lines ±1 kV for input/output lines	±2 kV for power supply lines ±1 kV for input/output lines	Mains power quality should be that of a typical commercial or hospital environment.
Surge IEC 61000-4-5	±1 kV differential mode ±2 kV common mode	±1 kV differential mode ±2 kV common mode	Mains power quality should be that of a typical commercial or hospital environment.

Voltage dips, short interruptions, and voltage variations on power supply input lines. IEC 61000-4-11	>95% dip in 0.5 cycle 60% dip in 5 cycles 30% dip for 25 cycles >95% dip in 5 seconds	>95% dip in 0.5 cycle 60% dip in 5 cycles 30% dip for 25 cycles >95% dip in 5 seconds	Mains power quality should be that of a typical commercial or hospital environment. If the user of the Spot Vital Signs LXi requires continued operation during power mains interruptions, it is recommended that the Spot Vital Signs LXi be powered from an uninterruptible power supply or battery.
Power frequency (50/60Hz) magnetic field IEC 61000-4-8	3 A/m	3 A/m	Power frequency magnetic fields should be at levels characteristic of a typical location in a typical commercial or hospital environment.

### Electromagnetic Immunity

The Spot Vital Signs LXi is intended for use in the electromagnetic environment specified below. The customer or user of the Spot Vital Signs LXi should assure that it is used in such an environment.

Immunity Test	IEC 60601 Test Level	Compliance Level	Electromagnetic Environment - Guidance
Conducted RF IEC 61000-4-6	3 Vrms 150 kHz to 80 MHz	3 Vrms	Portable and mobile RF communications equipment should be used no closer to any part of the Spot Vital Signs LXi, including cables, than the recommended separation distance calculated from the equation applicable to the frequency of the transmitter.  <b>Recommended separation distance</b> $d = (1.17) \sqrt{P}$
Radiated RF IEC 61000-4-3	3 V/m 80 MHz to 2.5 GHz	3 V/m	$d = (1.17) \sqrt{P}$ 80 MHz to 800 MHz $d = (2.33) \sqrt{P}$ 800 MHz to 2.5 GHz  where $P$ is the maximum output power rating of the transmitter in watts (W) according to the transmitter manufacturer and $d$ is the recommended separation distance in metres (m).  Field strengths from fixed RF transmitters, as determined by an electromagnetic site survey, <sup>a</sup> should be less than the compliance level in each frequency range. <sup>b</sup>  Interference may occur in the vicinity of equipment marked with the following symbol:  

Note 1: At 80 MHz and 800 MHz, the higher frequency range applies.

Note 2: These guidelines may not apply in all situations. Electromagnetic propagation is affected by absorption and reflection from structures, objects, and people.

<sup>a</sup> Field strengths from fixed transmitters, such as base stations for radio (cellular/cordless) telephones and land mobile radios, amateur radio, AM and FM radio broadcast and TV broadcast cannot be predicted theoretically with accuracy. To assess the electromagnetic environment due to fixed RF transmitters, an electromagnetic site survey should be considered. If the measured field strength in the location in which the Spot Vital Signs LXi is used exceeds the applicable RF compliance level above, the electrocardiograph should be observed to verify normal operation. If abnormal performance is observed, additional measures may be necessary, such as reorienting or relocating the electrocardiograph.

<sup>b</sup> Over the frequency range 150 kHz to 80 MHz, field strengths should be less than 3 V/m.



### Recommended Separation Distances Between Portable and Mobile RF Communications Equipment and the Spot Vital Signs LXi

The Spot Vital Signs LXi is intended for use in an electromagnetic environment in which radiated RF disturbances are controlled. The customer or user of the Spot Vital Signs LXi can help prevent electromagnetic interference by maintaining a minimum distance between portable and mobile RF communications equipment (transmitters) and the Spot Vital Signs LXi as recommended below, according to the maximum output power of the communications equipment.

Rated Max. Output Power of Transmitter (W)	Separation Distance According to Frequency of Transmitter (m)		
	150 kHz to 80 MHz $d = (1.17) \sqrt{P}$	80 MHz to 800 MHz $d = (1.17) \sqrt{P}$	800 MHz to 2.5 GHz $d = (2.33) \sqrt{P}$
0.01	0.117	0.117	0.233
0.1	0.37	0.37	0.74
1	1.17	1.17	2.33
10	3.70	3.70	7.37
100	11.70	11.70	23.30

For transmitters rated at a maximum output power not listed above, the recommended separation distance  $d$  in meters (m) can be estimated using the equation applicable to the frequency of the transmitter, where  $P$  is the maximum output power rating of the transmitter in watts (W) according to the transmitter manufacturer.

Note 1: At 80 MHz and 800 MHz, the separation distance for the higher frequency range applies.

Note 2: These guidelines may not apply in all situations. Electromagnetic propagation is affected by absorption and reflection from structures, objects, and people.



## 8

## Troubleshooting

This chapter provides helpful information in troubleshooting the Spot Vital Signs LXi.

### Error Codes

The following tables of error codes provide a quick reference of the descriptions and probable causes of error codes.

**Table 1. Informational Error Codes**

Internal Event Log Code Number	Displayed Device Code	Internal Event Log Description	Corrective Action
_n/a		Copyright notice displayed on powers up splash screen.	
_n/a		Message displays when the user attempts to start another print while a print job is currently printing.	Printing is already in progress
_n/a		Clear current reading.	
_n/a		Erase all readings.	
_n/a		Information screen telling the user how to operate the location identifier edit menu in Configuration Mode.	Use the navigation keys to edit characters and the SELECT key to stop editing.
_n/a		Message displays when Mod F cannot perform a STEP NIBP measurement and switches to normal method.	Restrict patient movement.
_n/a		Message displays when in MEM mode and there are no readings to display.	
_n/a		External devices configuration menu message when the user tries to exit the menu having enabling the information system, but not that Patient ID.	User must enable the Patient ID if using the information system.
_n/a		Message displays below txtPIDMsgB.	User must press SELECT and correct the problem.
_n/a		Information displays when the user enables device in external devices configuration menu.	User must connect the Spot Vital Signs LXi to an external device.
_n/a		Message displays below txtPIDMsgA	User must press SELECT when completed.
_n/a		Line displays below error/information message if the user can clear the error/condition.	User must press ACCEPT to clear.

**Table 1. Informational Error Codes**

Internal Event Log Code Number	Displayed Device Code	Internal Event Log Description	Corrective Action
_n/a			User decides whether to reset everything back go factory default values.
_n/a		Error condition occurs causing the unit to automatically shut down. The user cannot clear this message.	Spot Vital Signs LXi will shut down in 1 minute.
_n/a			User confirms to start printing.

**Table 2. Blood Pressure Error Codes**

Internal Event Log Code Number	Displayed Device Code	Internal Event Log Description	Corrective Action
10	C01	User abort.	
11	C03	Inflation too quick.	Check tubing and connections.
12	E10	Overpressure	Check patient.
13	C04	Major air leak.	Excessive inflation time; check for air leaks.
14	C05	Excessive arm movement	Excessive noise, check cuff placement; restrict patient movement.
15	C07	Auto cycle skipped, system busy.	Device will power down.
16	C07	Auto cycle skipped, NIBP reached too soon.	Device will power down.
17	C02	Auto zero failure.	Auto zero failure; check air obstruction; limit patient movement.
18	C04	Could not reach target pressure.	Excessive inflation time; check for air leaks.
19	E20	Missed A/D sample.	General internal malfunction. Call Technical Support.
20	E20	A/D timeout failure.	General internal malfunction. Call Technical Support.
21		NIPB NOT AVAILABLE.	Correct probe tip conditions. If problem persists, replace probe. If problem still persists, replace module.
22	E11	Malfunction	User should try another cycle. If problem persists, replace probe.
23	C06	Reinflation needed.	Measurement was outside of device's measurement range.
24	C05	Cycle took too long.	Check cuff placement; restrict patient movement.
25	C12	Ambient temp out of range.	Check internal temperature at probe well. Verify ambient temperature does not exceed operating specification.
26	C13	Battery failure	Battery failure; use wall transformer.

**Table 2. Blood Pressure Error Codes**

<b>Internal Event Log Code Number</b>	<b>Displayed Device Code</b>	<b>Internal Event Log Description</b>	<b>Corrective Action</b>
27	E11	> 10mm residual pressure > minutes.	Verify that the supply voltage is within specification.
28	E11	>15mm residual pressure >3 mins.	Verify that the supply voltage is within specification.
29	C02	Couldn't bleed pressure < 9 mmHg	Auto zero failure, check tubing for kinks and connection integrity, limit patient movement.
32		Termistor pulled away from the tip or heater broken.	Try another predict cycle. If the problem persists, replace probe.
33		Probe not responsive. Probe not characterized/calibrated.	Replace probe.
34		Probe not characterized/calibrated.	Replace probe.
41	C06	Low inflation; first step had largest value, first step's value > systolic value.	Measurement was outside of Spot Vital Signs LXi measurement range.
42	C06	Dump too soon; last step had largest value, next to last step's value > diastolic value; will not normally occur in auto-dump mode.	Check connections; restrict patient movement.
43	C05	Step too big systolic; difference in pressure between step above and step below systolic is too great.	Excessive noise; check cuff placement and limit movement.
44	C05	Step too big diastolic; difference in pressure between step above and step below diastolic is too great.	Excessive noise; check cuff placement and limit movement.
45	C05	Range error: calculated BP is outside of measurement range.	Excessive noise; check cuff placement and limit movement.
46	C05	Pressure reverse systolic; pressure of step above systolic is lower than pressure of step below systolic.	Excessive noise; check cuff placement and limit movement.
47	C05	Pressure reverse diastolic; pressure of step above systolic is lower than pressure of step below diastolic.	Excessive noise; check cuff placement and limit movement.
48	C05	Step too big MAP; difference in pressure between adjacent steps near MAP is too great.	Excessive noise; check cuff placement and limit movement.
49	C05	Too few steps; less than 5 steps	Excessive noise; check cuff placement and limit movement.
50	C05	Bad value diastolic; value of step below diastolic and step below that step are not consistent.	Excessive noise; check cuff placement and limit movement.
51	C05	Value reverse systolic; value of step above systolic is greater than value of step below systolic.	Excessive noise; check cuff placement and limit movement.
52	C05	Value reverse diastolic; value of step above systolic is greater than value of step below diastolic.	Excessive noise; check cuff placement and limit movement.

**Table 2. Blood Pressure Error Codes**

<b>Internal Event Log Code Number</b>	<b>Displayed Device Code</b>	<b>Internal Event Log Description</b>	<b>Corrective Action</b>
53	C05	No info - can't be produced by Mod F if they don't exist in the code.	Excessive noise; check cuff placement and limit movement.
54	C05	No info - can't be produced by Mod F if they don't exist in the code.	Excessive noise; check cuff placement and limit movement.
55	C05	No info - can't be produced by Mod F if they don't exist in the code.	Excessive noise; check cuff placement and limit movement.
56	C05	Out of memory; deflation contains too many steps. SW sets allowable limit of steps that can be stored and used for BP determination for a given cycle.	Excessive noise; check cuff placement and limit movement.
57	C05	Retarget error; cycle tried to retarget too many times. Only one allowed retarget allowed per cycle.	Excessive noise; check cuff placement and limit movement.
58	C05	Repump error: Tried to repump too many times. Limit is set to 3 repumps. This can occur on a cycle with bad signal to noise ratio or if a subject's pulses are so small that pulses above the diastolic ratio are not detectable with the lowest allowed thread threshold.	Excessive noise; check cuff placement and limit movement.
59	C05	Systolic curve fit error; the steps on the systolic side of the envelope could not be curve fit. Causes include: too few or too many steps sent to curve fit routine; math error in curve fit routine.	Excessive noise; check cuff placement and limit movement.
60	C05	Diastolic curve fit error; the steps on the systolic side of the envelope could not be curve fit. Causes include: too few or too many steps sent to curve fit routine; math error in curve fit routine.	Excessive noise; check cuff placement and limit movement.
61	C05	Systolic slope error; slope of curve fit of systolic points has a slope out of range. Can occur with bad cuff fit, rapidly changing BP etc.	Excessive noise; check cuff placement and limit movement.
62	C05	Diastolic slope error; slope of curve fit of diastolic points has a slope out of range. Can occur with bad cuff fit, rapidly changing BP etc.	Excessive noise; check cuff placement and limit movement.
63	C05	Systolic extrapolation error; the systolic pressure that is represented by the systolic ratio is outside of the data sent to the curve fit routine.	Excessive noise; check cuff placement and limit movement.
64	C05	Diastolic extrapolation error; the systolic pressure that is represented by the diastolic ratio is outside of the data sent to the curve fit routine.	Excessive noise; check cuff placement and limit movement.
65	C05	Peak range error; the height of the peak of the envelope is outside normal limits.	Excessive noise; check cuff placement and limit movement.
66	C05	Reinflation too late.	Excessive noise; check cuff placement and limit movement.

**Table 2. Blood Pressure Error Codes**

Internal Event Log Code Number	Displayed Device Code	Internal Event Log Description	Corrective Action
67	C06	High heart rate.	Unable to determine blood pressure; pulse rate may be out-of-range.
68	Err	Too many reinflates.	Restrict patient movement.
69	C06	Problem reading the module's EEPROM or saving to the module's EEPROM.	Verify that the supply voltage is correct. Try to make changes. If problem persists, replace module.
70	C06	Problem reading the probe's EEPROM.	Verify that the supply voltage is correct. Try to make changes.
78	C06	The probe non-volatile error log memory error detection mechanism detected error.	Measurement was outside of device's measurement range.
79	C06	The module's non-volatile error log memory error detecting mechanism detected an error.	Measurement was outside of device's measurement range.
5600	Err	Invalid ModF algorithm.	
5601	Err	Invalid ModF init code.	
5602	Err	Invalid ModF PMode.	
5603	Err	Invalid ModF target pressure.	
5604	Err	Invalid ModF configuration.	

**Table 3. Post Error Codes**

Internal Event Log Code Number	Displayed Device Code	Internal Event Log Description	Corrective Action
80	E30	FPROM checksum error.	General internal malfunction; contact technical support.
81	E31	RAM test failure.	General internal malfunction; contact technical support.
82	E32	Factory EEprom checksum error.	General internal malfunction; contact technical support.
83	E33	User EEprom checksum error.	General internal malfunction; contact technical support.
84	E34	A/D converter failure.	General internal malfunction; contact technical support.
85	E35	SpO2 module failure.	General internal malfunction; contact technical support.
86	E36	Diatek module failure	General internal malfunction; contact technical support.
87	E37	Printer problem.	General internal malfunction; contact technical support.
88	E38	Real time clock failure.	Date and time not set; see "Set the Date and Time Configurations" in the Directions for Use.

**Table 3. Post Error Codes**

Internal Event Log Code Number	Displayed Device Code	Internal Event Log Description	Corrective Action
89	E39	No calibration signature.	General internal malfunction; contact technical support.
90	E40	Bad NIBP calibration record.	General internal malfunction; contact technical support.
91	E41	Stepper valve bad.	General internal malfunction; contact technical support.
92	E42	8bit substitute for 16bit errors.	Internal communications error. Disconnect the battery and wait 5 minutes. Reconnect the battery, and then see "Set the Date and Time Configurations" in the Directions for Use.
93	E43	Error log checksum error.	General internal malfunction; contact technical support.
94	Err-E44	POST que full.	General internal malfunction; contact technical support.
95	E44 E45	POST que full.	General internal malfunction; contact technical support.

**Table 4. SureTemp Plus Temperature Error Codes**

Internal Event Log Code Number	Displayed Device Code	Internal Event Log Description	Corrective Action
121	E0.4	Probe is over temperature (112° F / 44.4° C).	Correct probe tip conditions. If problem persists, replace probe.
122	E0.1	Excessive heater energy.	Try another predict cycle. If problem persists, replace probe.
123	23	Host interface error.	Try another predict cycle. If problem persists, replace probe.
124	A^!	Device outside operating temperature range.	Decrease ambient temperature.
125	Av!	Device outside operating temperature range.	Increase ambient temperature.
126	26	Invalid SureTemp algorithm.	Try another predict cycle. If problem persists, replace probe.
127	b^	Battery voltage over the algorithm's maximum value.	Contact Technical Service.
128	bv	Battery voltage under the algorithm's minimum value.	Contact Technical Service.
129	29	Battery voltage not set.	Try another predict cycle. If problem persists, replace probe.
130	30	Prediction algorithm not set.	Try another predict cycle. If problem persists, replace probe.
131	31	Ambient temperature not set.	Try another predict cycle. If problem persists, replace probe.



**Table 4. SureTemp Plus Temperature Error Codes**

Internal Event Log Code Number	Displayed Device Code	Internal Event Log Description	Corrective Action
132	E0.5	No probe temperature rise.	Try another predict cycle. If problem persists, replace probe.
133	E0.9	Probe EEPROM is uninitialized. Bad probe gain.	Calibrate probe or replace probe.
134	E0.9	Probe EEPROM is uninitialized. Bad probe response value.	Calibrate probe or replace probe.
145	E0.2	A/D measurement overrun - pulse too long.	Patient or environmental temperature conditions may be too low. Verify conditions at 80° F and 50° F respectively. If conditions are valid and problem persists, replace probe. If problem still persists replace device.
146	E0.2	A/D Measurement underrun - pulse too short.	Patient or environmental temperature conditions may be too high. Verify conditions at 110° F and 104° F respectively. If conditions are valid and problem persists, replace probe. If problem still persists, replace device.
147	E4.1	A/D measurement overrun - RCAL pulse too long.	If problem persists, replace device.
148	E4.1	A/D measurement underrun - RCAL pulse too short.	If problem persists, replace device.
149	E4.0	A/D measurement overrun - PTB pulse too long.	If problem persists, replace device.
150	E4.0	A/D measurement underrun - PTB pulse too short.	If problem persists, replace device.
151	E0.2	A/D measurement overrun - timeout.	If problem persists, replace device.
152	E0.9	Probe EEPROM is uninitialized.	Bad probe A/D calibration.
159	bv	Displayed when battery voltage is too low.	
160	b^	Displayed when battery voltage is too high.	
161	E4.2	Reference power supply malfunction.	If problem persists, replace device.
162	E4.8	Device not calibrated.	Calibrate device.
163	E4.9	Missing probe well - cycle will not start.	Insert probe well.
165	E4.3	Device EEPROM save failure.	Verify that the batteries are fresh. Try to make changes again. If problem persists, replace device.
166	E0.8	EEPROM CRC Failure. (CONFIG_TRANSFER_FAILURE)	Verify that the batteries are fresh. Try again, if problem persists, replace the component that is indicated.
167	E4.4	Device EEPROM read/save failure. (CONFIG_START_FAILURE)	Verify that the batteries are fresh. Try to make changes again. If problem persists, replace device.
168	E4.5	Device EEPROM read/save failure. (CONFIG_SLAVE_ACK_FAILURE)	Verify that the batteries are fresh. Try to make changes again. If problem persists, replace device.

**Table 4. SureTemp Plus Temperature Error Codes**

Internal Event Log Code Number	Displayed Device Code	Internal Event Log Description	Corrective Action
169	E4.6	Device EEPROM read/save failure. (CONFIG_MASTER_ACK_FAILURE)	Verify that the batteries are fresh. Try to make changes again. If problem persists, replace device.
170	E0.6	Probe EEPROM read failure. (CONFIG_NULL_CHAR_FAILURE)	Verify that the batteries are fresh. Try to make changes again. If problem persists, replace device.
171	71	Device EEPROM access failure. (CONFIG_ACQUIRE_FAILURE)	Try another predict cycle. If problem persists, replace probe.
172	72	Device EEPROM access failure. (CONFIG_RELEASE_FAILURE)	Try another predict cycle. If problem persists, replace probe.
173	73	Device EEPROM access failure. (CONFIG_INVALID_PTR_FAILURE)	Try another predict cycle. If problem persists, replace probe.
174	E4.7	Device EEPROM initialization failure. (CONFIG_INITIALIZE_FAILURE)	If problem persists, replace device.
175	E0.7	Probe EEPROM is un-initialized. (CONFIG_UNINITIALIZED_PROBE)	Verify that the batteries are fresh. If problem persists, replace probe.
180	E5.0	Heater stuck on. (ERROR_HEATER_ON)	If problem persists, replace device.
181	E5.0	Heater stuck off. (ERROR_HEATER_OFF)	If problem persists, replace device.
182	E5.0	Heater on when should be off. (ERROR_HEATER_VOLTAGE_HIGH_Q)	If problem persists, replace device.
183	E5.0	Heater on when should be off. (ERROR_HEATER_VOLTAGE_Q_HIGH_IMPEDANCE)	If problem persists, replace device.
184	E5.0	Heater is off when it should be on. (ERROR_HEATER_VOLTAGE_LOW)	If problem persists, replace device.
185	E5.2	Heater hardware failsafe failure. (ERROR_HEATER_FAILSAFE)	If problem persists, contact Technical Service.

**Table 5. SpO<sub>2</sub> Error Codes**

Internal Event Log Code Number	Displayed Device Code	Internal Event Log Description	Corrective Action
1		Missing or disconnected sensor.	Adjust or replace sensor.
3	--	No pulse from sensor.	Adjust or replace sensor.
4	E7	Communications failure.	Retake reading; contact Technical Service.
5		8-second timeout interval	
6	C8	Defective or bad SpO <sub>2</sub> sensor.	Replace sensor.
	C9	SpO <sub>2</sub> time limit exceeded.	Remove sensor from patient.

**Table 6. Comms Errors**

<b>Internal Event Log Code Number</b>	<b>Displayed Device Code</b>	<b>Internal Event Log Description</b>	<b>Corrective Action</b>
1000	Err	Invalid Operation in this Context.	Internal error, contact Technical Service.
1001	Err	Auto zero in progress.	Internal error, contact Technical Service.
1002	Err	Bad checksum.	Internal error, contact Technical Service.
1003	Err	Unimplemented command.	Internal error, contact Technical Service.
1004	Err	Buffer Overflow.	Internal error, contact Technical Service.
1005	Err	Overrun error.	Internal error, contact Technical Service.
1006	Err	Wrong data count.	Internal error, contact Technical Service.
1007	Err	FEPROM erase error.	Internal error, contact Technical Service.
1008	Err	FEPROM programming error	Internal error, contact Technical Service.
1009	Err	Bad Motorola record.	Internal error, contact Technical Service.
1010	Err	A/D channel locked.	Internal error, contact Technical Service.
1011	Err	RTC not present.	Internal error, contact Technical Service.
1012	Err	Attempt to reference nonexistent cycle.	Internal error, contact Technical Service.
1013	Err	Data range error.	Internal error, contact Technical Service.
1014	Err	Alarm pair range error.	Internal error, contact Technical Service.
1015	Err	No POST error to clear.	Internal error, contact Technical Service.
1016	Err	Can't clear this POST error.	Internal error, contact Technical Service.
1017	Err	Command not command type.	Internal error, contact Technical Service.
1018	Err	NAK from ST3800 protocol.	Internal error, contact Technical Service.
1019	Err	No wireless link.	Internal error, contact Technical Service.

**Table 7. Comms Host Errors**

<b>Internal Event Log Code Number</b>	<b>Displayed Device Code</b>	<b>Internal Event Log Description</b>	<b>Corrective Action</b>
2001	Err	Timeout.	Internal error, contact Technical Service.
2002	Err	Incorrect response header.	Internal error, contact Technical Service.
2003	Err	Incorrect response checksum.	Internal error, contact Technical Service.
2004	Err	Too much received data.	Internal error, contact Technical Service.
2005	Err	User cancelled.	Internal error, contact Technical Service.
2006	Err	User paused.	Internal error, contact Technical Service.

**Table 8. Printer Errors**

<b>Internal Event Log Code Number</b>	<b>Displayed Device Code</b>	<b>Internal Event Log Description</b>	<b>Corrective Action</b>
5400	Err	Problem with the printer	Check all options; if problem persists, contact Technical Service.
5401	Err	Printer is not responding.	
5402	Err	Displayed when print started and printer is out of paper.	Printer head will not shut all the way or too much paper.
5403	Err	Displayed when printing started and print head is not closed in place.	Add paper.

**Table 9. Spot Vital Signs LXi Errors**

<b>Internal Event Log Code Number</b>	<b>Displayed Device Code</b>	<b>Internal Event Log Description</b>	<b>Corrective Action</b>
5500		Unknown error code.	
5501	Err	Displayed when battery is too low for unit to continue operating.	Charge battery; use wall transformer.
5502	Err	Key stuck error causing the unit to be automatically shut down.	

**Table 10. 802.11 b Radio Errors**

LED	LED Color	Function
Power	Off	Bridge is not receiving power.
	Red	Bridge failed its Power On Self Test (POST) and is not configured for wireless communication.
	Amber	Bridge passed its POST but is not configured for wireless communication.
	Green	Bridge passed its POST and is configured for wireless communication.
Link	Off	Bridge is not receiving power.
	Red	Bridge is searching for an Access Point.
	Green	Wireless network and MAC have associated with an Access Point.
Comm	Off	No power or no wireless TCP session is established and no physical serial connection is detected.
	Red	No wireless TCP session is established; a physical connection is detected.
	Blinking Red	A physical serial connection was detected and there is serial traffic present on that connection, but no wireless TCP session is established.
	Amber	A wireless TCP connection is established but no physical serial connection is detected (i.e. no serial cable is attached to the Bridge).
	Blinking Green	A wireless TCP session is established, a physical serial connection is detected, and the Bridge is transmitting or receiving data across the wired serial port.
	Green	A wireless TCP session is established, a physical serial connection is detected, but there is no active data movement across the wired serial port.

**NOTE:**The 802.11 a/b/g radio has no functional LED displays.

## Radio Test

Refer to Manufacturer's Directions for Use.

# Service Work Checklist

## Spot Vital Signs

Model Number	Serial Number	BP Cycle Count	Technician	Date

Test	Test Data	Pass/Fail	Test Specification
Unit SW Version			
SPO2 SW Version			
Thermometry SW Version			
Unit Pressure @ 0 mmHg			+/- 1 mmHg
Unit Pressure @ 50 mmHg			+/- 1 mmHg
Unit Pressure @ 150 mmHg			+/- 1.5 mmHg
Unit Pressure @ 250 mmHg			+/- 2.0 mmHg
Test Voltage @ 5.5 V			+/- 0.1 VDC
Current Test – Sleep State			< 0.5 A
Current Test – Patient DAQ			< 1.25 A
Current Test – Valve Pump			< 2.0 A
Noise Level			< 0.05 mmHg
Button Test			Pass/Fail
Interface Test			Pass/Fail
Leak Test			<= 6mmhg in 15 seconds
Dump Test			< 10 Seconds
Inflation Test			< 7 Seconds
Valve Control Test			Pass/Fail
Over Pressure Test			296 to 329 mmHg
SPO2 Sensor - Masimo			81% +/- 3% 61bpm +/- 1bpm
SPO2 Sensor - Nellcor			90% +/- 1% 60bpm +/- 1bpm
Temperature Calibration Suretemp Plus			96.8 +/- 0.2F 105.8 +/- 0.2F
Temperature Calibration Braun Pro 4000			96.8 +/- 0.2F 105.8 +/- 0.2F
Temperature Cal Key Suretemp Plus			97.3 +/- 0.2 F
Radio Ping Test	Pass or Fail		Pass

# Radio Configuration Utility

This CD configures the Spot Vital Signs LXi Radio to a local network. Refer to DFU.





## 9

## Supplies and Accessories

## Blood Pressure

**Table 1. Reusable Blood Pressure Cuffs (1 per pack)**

REF	Size	REF	Size
4500-01	Child	4500-03	Large Adult
4500-02	Adult	4500-04	Thigh

**Table 2. Reusable Blood Pressure Cuffs (1 per pack)**

REF	Size	REF	Size
REUSE-07-2MQ	Infant	REUSE-11-2MQ	Adult
REUSE-08-2MQ	Small Child	REUSE-12-2MQ	Large Adult
REUSE-09-2MQ	Child	REUSE-13-2MQ	Thigh
REUSE-10-2MQ	Small Adult		

**Table 3. Disposable Blood Pressure Cuffs (5 per box)**

REF	Size	REF	Size
SOFT-07-2MQ	Infant	SOFT-11-2MQ	Adult
SOFT-08-2MQ	Small Child	SOFT-12-2MQ	Large Adult
SOFT-09-2MQ	Child	SOFT-13-2MQ	Thigh
SOFT-10-2MQ	Small Adult		

**Table 4. Miscellaneous Supplies and Accessories**

REF	Description	REF	Description
4500-30	Blood Pressure Hose (5ft/1.5M)	4500-31	Blood Pressure Hose (10ft/3M)
4500-32	Blood Pressure Hose (8ft/2.4M)		

# Temperature

**Table 5. SureTemp Plus**

REF	Description
02895-000	SureTemp Plus Oral Probe and Well (9 feet/2.7M)
02895-100	SureTemp Plus Rectal Probe and Well (9 feet/2.7M)
02894-0000	SureTemp Plus Oral Well
02894-1000	SureTemp Plus Rectal Well
06138-000	SureTemp Plus Temperature Calibration Key
01802-110	9600 Plus Calibration Tester
05031-101	Disposable SureTemp Plus Probe Covers (1,000 covers, packaged 25/box)
20500-025M	Probe Cover-Box 25
400194	Assy, Suretemp Plus Components, Spot Vital Signs LXi
400195	PCA, Suretemp Plus OEM without EDAC Calibrated
400196	PCA, EDAC, Spot Vital signs LXi

**Table 6. Braun ThermoScan PRO 4000**

REF	Description
04000-200	Braun ThermoScan PRO 4000 Thermometer (for North America, South America, and Asia Pacific)
04000-600	Braun ThermoScan PRO 4000 Thermometer (for Europe, Middle East, and Africa)
05075-800	Braun ThermoScan PRO 4000 Disposable Probe Covers (Case of 800 covers for North America, South America, and Asia Pacific)
04000-800	Braun ThermoScan PRO 4000 Disposable Probe Covers (Case of 800 covers for Europe, Middle East, and Africa)
01802-110	9600 Plus Calibration Tester
53020-0000	Braun ThermoScan PRO 4000 Rechargeable Battery Pack
4500-53	Braun Unlocking Key
4500-54	Repair-Braun with rechargeable batteries

# Pulse Oximetry

## Masimo Accessories

**Table 7. Adhesive Sensors: Single-Patient Use**

Catalog #	Description	Weight Range	Quantity
NEO-WRAP-RP	Replacement Wrap Neo Adhesive		
LNCS-INF-3	Disposable Adhesive Finger Sensor-Infant		
INF-WRAP-RP	Replacement Wrap Infant Adhesive		
YI-AD	Multisite Adhesive Wrap AD/PED/NEO, YI Sensor		
YI-FM	Multisite Foam Wrap AD/PED/NEO, YI Sensor		
LNCS-YI	Multisite Reusable Sensor		
LNCS-TC-I	Reusable Ear Sensor		
LNCS-NEO-L-3	Disposable Adhesive Finger Sensor- NEO/Adult		
LNCS-ADTX	Adhesive Finger Sensor - Adult (20 per case)	>30 kg	LNCS-ADTX
LNCS-PDXTX	Adhesive Finger Sensor - Pediatric (20 per case)	10 to 50 kg	LNCS-PDXTX
LNCS INF-L	Adhesive Finger Sensor - Infant (20 per case)	3 to 20 kg	LNCS INF-L
LNOP-ADT	Adult sensor	>66 lbs (30 kg)	20
LNOP-PDT	Pediatric sensor	22 to 110 lbs (10 to 50 kg)	20
LNOP-NEO	Neonatal sensor	<22 lbs (10 kg)	20
LNOP-NEOPT	SofTouch neonatal preterm sensor	<2.2 lbs (1 kg)	20

**Table 8. Reusable Sensor**

Catalog #	Description	Weight Range	Quantity
LNCS-TC-I	Reusable Ear Sensor		
LNCS-YI	Multisite Reusable Sensor		
LNCS-DCI	Finger sensor - adult	>66 lbs (30 kg)	1
LNCS-DCIP	Finger sensor - pediatric	10 to 50 kg	1
LNOP-DCI	Finger clip probe - adult	>66 lbs (30 kg)	1
LNOP-DCIP	Finger clip probe - pediatric	10 to 50 kg	1

**Table 9. Sensor Cables**

Catalog #	Description	Weight Range	Quantity
LNC-4-WA	4-foot cable with DB-9 connector for LNCS	NA	1
LNC-10-WA	10-foot cable with DB-9 connector for LNCS	NA	1
PC-04	4-foot cable with sensor connector	NA	1

**Table 9. Sensor Cables**

<b>Catalog #</b>	<b>Description</b>	<b>Weight Range</b>	<b>Quantity</b>
PC-08	8-foot cable with sensor connector	NA	1
PC-12	12-foot cable with sensor connector	NA	1

## Nellcor Accessories

**Table 10. OxiMax Adhesive Sensors: Single-Patient Use**

Catalog #	Description	Weight Range	Quantity
MAX-AI	MAX-A Adhesive Sensor, adult	>66 lbs (30 kg)	Case of 24
MAX-PI	MAX-P Adhesive Sensor, pediatric	22 to 110 lbs (10 to 50 kg)	Case of 24
MAX-II	MAX-I Adhesive Sensor, infant	6.5 to 44 lbs (3 to 20 kg)	Case of 24
MAX-RI	MAX-R Adhesive Sensor, adult nasal	>110 lbs (50 kg)	Case of 24

**Table 11. OxiMax OxiCliq® Sensors: Reusable Cable with Adhesive Sensor Bandage**

Catalog #	Description	Weight Range	Quantity
OC-3	OxiCliq Sensor Cable (3 ft / 91cm)	N/A	1
OXCCLIQ-PI	OxiCliq P, pediatric	22 to 110 lbs (10 to 50 kg)	Case of 24

**Table 12. OxiMax Resuable Sensors**

Catalog #	Description	Weight Range	Quantity
DS-100A	Durasensor® DS-100A finger-clip sensor, adult	>88 lbs (40 kg)	1
OXI-A/N	Oxiband® OXI-A/N, adult/neonatal	< 6.5 lbs or > 88 lbs (<3 kg or >40 kg)	1
OXI-P/I	Oxiband OXI-P/I, pediatric/infant	6.5 lbs to 88 lbs (3 to 40 kg)	1
D-YS	Dura-Y® D-YS, multisite sensor	>2.2 lbs (1 kg)	1
D-YSE	D-YSE ear clip for Dura-Y sensor	>66 lbs (30 kg)	1
D-YSPD	PediCheck™ D-YSPD pediatric spot-check sensor	6.5lbs to 88 lbs (3 to 40 kg)	1

**Table 13. OxiMax Sensor Cables**

Catalog #	Description	Weight Range	Quantity
DOC-10	DOC-10 (10 ft/3M)	N/A	1

## Miscellaneous

<b>REF</b>	<b>Description</b>
4500-60	Mobile Stand, Spot Vital Signs LXi
4500-62	Wall Mount, Spot Vital Signs LXi
4500-84	Lead Acid Battery
705310	Directions for Use
705298	Quick Reference Card
4500-89	Service Manual
4500-11	Child Inf. Bag, 2 Tube Monitor
4500-12	Adult Bag, 2 Tube Monitor
4500-13	Large Adult Inf. Bag, 2 Tube Monitor
4500-14	Thigh Inf. Bag, 2 Tube Monitor
4500-75	Kit, Desk Plate, Spot Vital Signs LXi
4500-89	Service Manual, Spot Vital Signs LXi
4500-150E	In-Service CD, Spot Vital Signs LXi
4500-100	Carrying Case, Spot Vital Signs LXi
4500-101A	AC Power Transformer (desktop transformer, line cord not included)
4500-200	Cuffkit, Child, Adult, Thigh, 2T Cuff & Bag
4500-202	Cuffkit, Small Child, Child, Small Adult 2T
4500-400	Line Cord (United States/Canadian/Japanese version)
4500-402	Line Cord (European version)
4500-404	Line Cord (United Kingdom version)
4500-406	Line Cord (Australian Version)
4500-408	Line Cord (South African version)
4500-450	Transformer Mount, Spot Vital Signs LXi
4500-500	Kit, Printer, Spot Vital Signs LXi
4500-505	Printer Rechargeable Replacement Battery
4500-510	Printer Paper (10 rolls)
4500-520	Label Paper (10 rolls) and Cleaning Kit
4500-900	Kit, Dev Conn SDK Developers
4500-905	Repair Tool Software CD Kit
4500-906	Spot Vital Signs LXi Configuration CD
4500-907	Spot Vital Signs LXi Firmware Loader CD
4500-915	Image Team 4600 2D Bar Code Scanner Kit
4500-920	Radio Kit
4500-921	Radio Directions for Use
4500-922	802.11 a/b/g Spot Vital Signs LXi Radio Kit

<b>REF</b>	<b>Description</b>
4500-923	Spot Vital Signs LXi a/b/g Radio Directions for Use
4500-925	USB 2.0 Cable for Wired Connectivity
4500-926	Cable for Wired Connectivity, Keyspan (USB to serial adapter)
4500-927	Spot Vital Signs LXi USB/serial Cable Kit
5200-08	Calibration T Fitting

## Service Contracts

<b>REF</b>	<b>Description</b>
4500-BT0	One-Year Service Contract, BP & Temperature
4500-BTS	One-Year Service Contract, BP & Temperature



# 10

## Field Replaceable Units

The following list identifies the available FRUs for Spot Vital Signs LXi. To order an FRU, contact Welch Allyn Technical Support.

**Table 1. Spot Vital Signs LXi Base Components**

<b>Component Number</b>	<b>Object Description</b>
400163	ASSY, POWER HARNESS, Spot Vital Signs LXi
400170	ASSY, PUMP HARNESS
400198	PCA, SERIAL INTERFACE, Spot Vital Signs LXi
400199	PCA, MAIN, Spot Vital Signs LXi
400200	BASE UNIT, SURETEMP, NELLCOR - Spot Vital Signs LXi
400203	BASE UNIT COMPONENTS, Spot Vital Signs LXi
400207	LANGUAGE COMPONENTS, ENG, Spot Vital Signs LXi
4500-901	Spot Vital Signs LXi Pump and Pump Tubing Kit
4500-902	Spot Vital Signs LXi Pump Tubing Kit
4500-84	Lead Acid Battery
4500-101A	AC Power Transformer
400387	PBCA BP OEM, (MOD F)
400720	ASSY, BALLAST HARNESS, Spot Vital Signs LXi
400732	ASSY, BATTERY, Spot Vital Signs LXi
401082	Assy, Bezel and Window, Spot Vital Signs LXi
401250	Assy, Fan Unit Cooling
404940	PCA, Main, Spot Vital Signs LXi
421051-12	TUBING, 1/8 X 1/4 X 2.50
421051-9	TUBING, 1/8 X 1/4 X 0.95
59P586	FOOT, RUBBER
620028-E	LABEL, CAUTION
620217	FITTING, "T", 1/8 X 1/16X 1/8
700101	HSG, HANDLE, LXi
700102	HSG, HANDLE INSERT, LXi Ultra
700103	HSG, REAR, LXi
700105	HSG, BATT DOOR, Spot Vital Signs LXi
700110	BUMPER, LCD, Spot Vital Signs LXi

**Table 1. Spot Vital Signs LXi Base Components**

700114	SWITCH ARRAY, Spot Vital Signs LXi
700119	INVERTER, LCD
705653	HOUSING, FRONT, Spot Vital Signs LXi
704423	HSG, PANEL, SPO2-BLANK, Spot Vital Signs LXi
4500-89	SERVICE MANUAL, Spot Vital Signs LXi
401427	LABEL, ICON ID, Spot Vital Signs LXi
700863	CBL,FLX, 1/2mm,15POS,1.0"
704375	FLEX, MAIN, Spot Vital Signs LXi
703956	LABEL, BATTERY
701040	FITTING, PLASTIC L, 1/16 X 1/16
701502	Valve,Pneumatic,6PSI,5V,TH
703077	STANDOFF, PCB, BROACHING, #4 X .500 LG
703118	BATTERY CLIP, AA, SINGLE
703354	DISPLAY,LCD,320X240,BLITE,MONO,3.3V,5.7"
703355	FILTER, AIR, 1/8 BARBS
705284	Spot Vital Signs LXi Warranty Card English
705298	QRC, Spot Vital Signs LXi English
705310	DFU, Spot Vital Signs LXi English
703842	TUBING, SILICONE, .063ID X .125OD X 5.50

**Table 2. SureTemp Plus Components**

<b>Component Number</b>	<b>Object Description</b>
02692-100	PROBE ASSY,ORAL 9FT
02894-0000	ASSY,PRB WLL,BLUE,OEM,M690_692
400194	ASSY, SURETEMP+, COMPONENTS, Spot Vital Signs LXi
400195	PCA, SURETEMP+, OEM W/O EDAC, CALIBRATED
400196	PCA, EDAC, Spot Vital Signs LXi
700111	HOUSING, THERM OEM POD, Spot Vital Signs LXi
700112	PLATE, POD MOUNTING, Spot Vital Signs LXi
700858	CBL,FLX,1MM,6POS
700859	CBL,FLX,1MM,8POS
70999-0000	LABEL,SURETEMP TECHNOLOGY
02692-100	PROBE ASSY,ORAL 9FT

**Table 3. Braun ThermoScan PRO 4000 Components**

<b>Component Number</b>	<b>Object Description</b>
400652	PCA, BRAUN INTERFACE, Spot Vital Signs LXi
400831	BRAUN COMPONENTS, Spot Vital Signs LXi
700112	PLATE, POD MOUNTING, Spot Vital Signs LXi
700820	HSG, BOTTOM, BRAUN POD, Spot Vital Signs LXi
700822	HSG, BRAUN POD, Spot Vital Signs LXi
704365	WINDOW, BRAUN POD, Spot Vital Signs LXi
700859	CBL,FLX,1MM,8POS
703161	SECURITY LOCK, BRAUN POD, Spot Vital Signs LXi
703162	LATCH, BRAUN POD, Spot Vital Signs LXi
703164	CONTACT, BRAUN POGO, Spot Vital Signs LXi
703165	SPRING, COMPRESSION
703192	COVER, BRAUN SECURITY, Spot Vital Signs LXi

**Table 4. Masimo SpO<sub>2</sub> Components**

<b>Component Number</b>	<b>Object Description</b>
008-0648-00	MASIMO LNOP-DCI ADULT REUSABLE SENSOR
008-0960-00	MASIMO-LNCS-DCI ADULT REUSABLE SENSOR
008-0692-01	MASIMO - 8' INTERFACE CABLE
008-1013-00	SPO2 CABLE, LNCS, MASIMO, MINI-D, 4', EXP
400192	PCA, MASIMO OEM, Spot Vital Signs LXi
400205	MASIMO SPO2 COMPONENTS, Spot Vital Signs LXi
400555	PCA, MASIMO ADAPTOR, Spot Vital Signs LXi
400610	ASSY, CABLE, FLAT FLEX, SPO2
704422	HSG, PANEL, SPO2-MASIMO, LXi
705651	HOUSING, FRONT MASIMO, Spot LXi
711350	MASIMO MS-11 SPO2, STD, SW V4.6.0.2
LNC-10-WA	MASIMO, 10' EXT CABLE, LNCS/DB-9
LNC-4-WA	MASIMO, 4' EXT CABLE, LNC/DB-9
LNCS-ADTX	MASIMO, LNCS-ADTX ADULT ADHSV, 20 CASE
LNCS-DCI	MASIMO, LNCS-DCI ADULT REUSABLE SENSOR
LNCS-DCIP	MASIMO, LNCS-DCIP PED REUSABLE SENSOR
LNCS-INF-L	MASIMO, LNCS-INF-L INFANT ADHSV, 20 CASE
LNCS-PDTX	MASIMO, LNCS-PDTX PED ADHSV, 20 CASE
LNOP-ADT	DISPOSABLE ADHESIVE FINGER CLIP PROBE-AD
LNOP-DCI	REUSABLE FINGER CLIP PROBE-ADULT
LNOP-DCIP	REUSABLE FINGER CLIP PROBE-PEDIATRIC

**Table 4. Masimo SpO<sub>2</sub> Components**

<b>Component Number</b>	<b>Object Description</b>
LNOP-NEO	DISP ADHESIVE FINGER CLIP PROBE-NEONATE
LNOP-NEOPT	DISPOSABLE FINGER SENSOR-NEONATE
LNOP-PDT	DISP ADHESIVE FINGER CLIP PROBE-PEDIATRIC
PC-04	4-FOOT CABLE W/ SENSOR CONN
PC-08	8-FOOT CABLE W/ SENSOR CONN
PC-12	12-FOOT CABLE W/ SENSOR CONN

**Table 5. Nellcor SpO<sub>2</sub> Components**

<b>Component Number</b>	<b>Object Description</b>
400183	PCA, NELCOR OEM, Spot Vital Signs LXi
400201	NELLCOR SPO2 COMPONENTS, Spot Vital Signs LXi
400610	ASSY, CABLE, FLAT FLEX, SPO2
620377-1	"NELLCOR WORKS HERE" LABEL
704421	HSG, PANEL, SPO2-NELLCOR, LXi
704870	EVSPNELLCOR NELL3 PULSE OXIMETRY
DOC-10	CABLE, SPO2 EXTENSION, NELLCOR
DEC-4	EXTENSION CABLE 4 FT.
DS-100A	DURASENSOR, ADULT, DS-100A
D-YS	DURA-Y OXYGEN TRANSDER (1 sensor-40 wraps)
D-YSE	EAR CLIP (USE WITH DURA-Y SENSOR)
D-YSPD	PEDICHECK PEDIATRIC SPOT CHECK
MAX-AI	NELLCOR OXIMAX ADULT SENSOR (SU CS/24)
MAX-II	NELLCOR OXIMAX INFANT SENSOR (SU CS/24)
MAX-PI	NELLCOR OXIMAX PED SENSOR (SU CS/24)
MAX-RI	NELLCOR OXIMAX ADULT NASAL SEN (CS/24)
OC-3	NELLCOR OXICLIQ SENSOR CABLE
OXI-A/N	NELLCOR OXIBAND AD/NEO TRANSDUCER 1/50
OXICLIQ-PI	PEDIATRIC OXYGEN TRANSDUCER
OXI-P/I	NELLCOR OXIBAND PED/INF TRANSDUCER 1/50

**Table 6. Radio Components**

<b>Component Number</b>	<b>Object Description</b>
706514	Radio
4500-915	Image Team 4600 2D Barcode Scanner Kit
703878	Null Modem 9-Pin M/F 4-40
4500-920	Kit, Spot Vital Signs LXi 802.11 b Radio
4500-921	802.11 b radio Directions for Use
4500-922	Kit, Wireless Spot Vital Signs LXi 802.11 a/b/g Radio
4500-923	802.11 a/b/g Radio Directions for Use
4500-905	Repair Tool CD, Spot Vital Signs LXi
4500-906	Spot Vital Signs LXi Configuration CD
4500-907	Spot Vital Signs LXi Firmware Loader CD
4500-925	Cable for wired connectivity
4500-926	Cable for wired connectivity, Keyspan (USB to serial adapter)
4500-927	USB 2.0/serial cable kit



# 11

## Disassembly and Repair

This chapter provides the instructions for removing and replacing serviceable modules in the Spot Vital Signs LXi.

In general, re-assembly procedures are the reverse order of the disassembly procedures.



**WARNING** Electric shock hazard. There are no user-serviceable parts inside Spot Vital Signs LXi other than battery replacement (see “Battery Replacement” on page 46). An operator may only perform maintenance procedures specifically described in this manual. For service, refer the device to an Authorized Service Center.

**Note** Always disconnect the sealed lead-acid battery in the Spot Vital Signs LXi before performing any repair function.

### Tool list

Description	Part Number	Qty	Source
Blood Pressure Test Volume Repair Fixture	401028	1	Welch Allyn
Spot Vital Signs LXi Repair Software	401710	1	Welch Allyn
Service Manual, Spot Vital Signs LXi	4500-89	1	Welch Allyn
Spot Vital Signs LXi Directions for Use	705310	1	Welch Allyn
802.11 b Radio	4500-920	1	Welch Allyn
802.11 b Radio Directions for Use	4500-921	1	Welch Allyn
802.11 a/b/g Radio	4500-922	1	Welch Allyn
802.11 a/b/g Radio Directions for Use	4500-923	1	Welch Allyn
Spot Vital Signs LXi Manufacturing Process Specifications	70012082	1	Welch Allyn
Tester, Calibration, 9600 Plus	01802-110	1	Welch Allyn
SureTemp Oral Probe	02895-000	1	Welch Allyn
Blood Pressure Y-Tube, No Fittings 1/8 Tube	5082-183	1	Welch Allyn
Spot Vital Signs LXi Work Instructions	MPD WI-PS-0090	1	Welch Allyn
Needle Nose Pliers		1	Tool/Supply Store
Wire Cutter		1	Tool/Supply Store
Tweezers		1	Tool/Supply Store
#2 Phillips Screwdriver		1	Tool/Supply Store

Description	Part Number	Qty	Source
T10 Torx Driver		1	Tool/Supply Store
4" PVC Pipe		1	Tool/Supply Store
Soldering Station		1	Tool/Supply Store
Cable Tie Tool - T9921	GS2B	1	Marsh Electronics +1 800 877-8919
*Setra Pressure Meter	2270-01	1	Setra +1 800 257 3872
*Nitech Pressure Meter	2000 in	1	Nitech +1 800 547 6557
Nellcor Sensor Ext Cable (4' Cable)	Dec-4	1	Nellcor +1 800 635 5267
Nellcor Sensor Ext Cable (8' Cable)	Dec-8	1	Nellcor +1 800 635 5267
Nellcor Sensor	DS-100A	1	Nellcor +1 800 635 5267
Masimo SpO <sub>2</sub> Tester	1795	1	Masimo +1 800 326-4890
Nellcor SRC-MAX SpO <sub>2</sub> Tester	SRC-MAX	1	Nellcor +1 800 635 5267
Masimo Patient Cable	1005	1	Masimo +1 800 326-4890
Masimo Adult SpO <sub>2</sub> Reusable Sensor	1269	1	Masimo +1 800 326-4890
Digital Volt Meter with 4 1/2 Digit Display		2	Electronics Supply Store
Power Supply: 0-20 Vdc adjustable with 0-3A output		1	Electronics Supply Store
Wireless Router		1	Electronics Supply Store
Ethernet Cable		1	Electronics Supply Store
IBM compatible computer Windows 2000, XP, NT4		1	

\* Only requires one of the pressure meters

### To disassemble Spot Vital Signs LXi:

1. Disconnect the power and all accessories from the Spot Vital Signs LXi.
2. Remove the four screws holding the battery door using a phillips-head screwdriver. Remove the battery door to expose the battery.

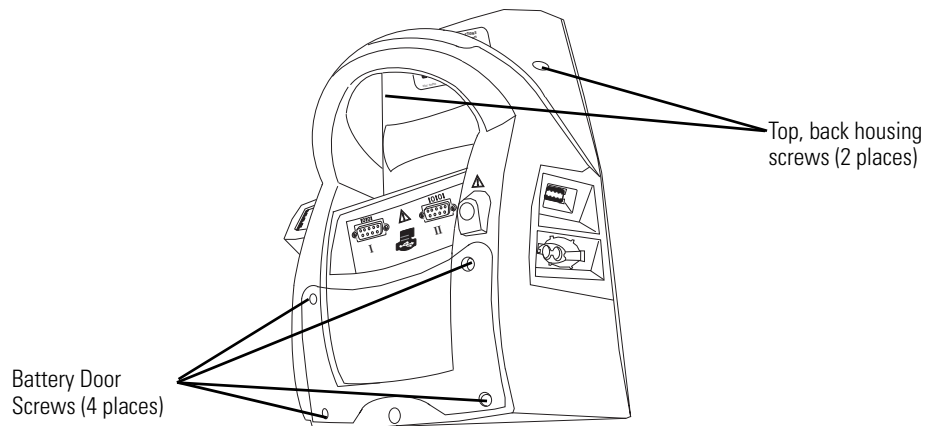

3. Tip the Spot Vital Signs LXi backward and slide the battery out. Disconnect the one-way connector.



4. Remove the two screws inside the battery housing that are identified with arrows molded into the housing and the two screws at the top of the back upper housing.
5. Hold the device together, lay the back housing on the bench, and carefully lift the top housing off.

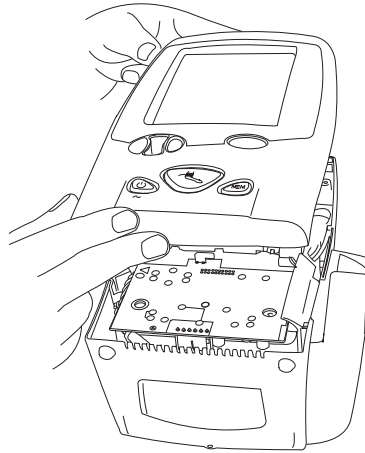

6. Remove the screw and slightly lift the circuit board from the right facing side and disconnect the flex cable (J103).

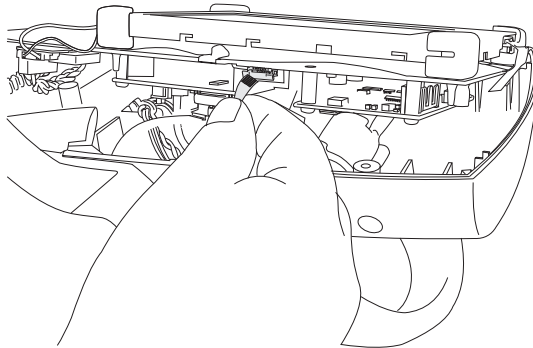

7. Observe the locations of the two tubes before disconnecting. Lift and disconnect the wire harnesses and the pneumatic tubing. The two wire harnesses are a 6-wire harness that connects to J104 and a 2-wire harness that connects to J80 on the small, mounted blood pressure board.

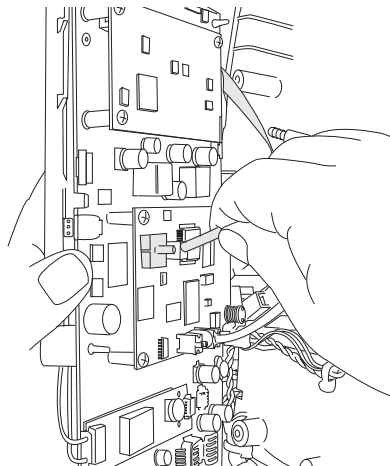

8. Disconnect the red electrical connector and the gold ribbon connector. This is located on the main board. Lift up the tab on the white cable retainer so cable can slide out after it is unplugged.

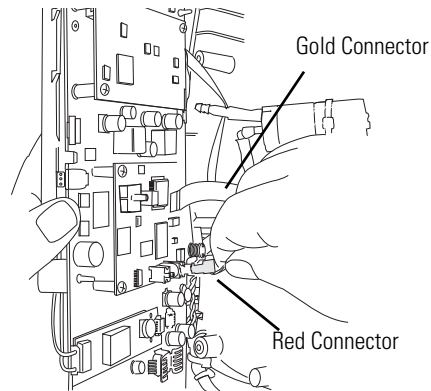

9. Lift the flap on the beige connector (large ribbon cable) to remove the main board. This releases the serial board cable from connector J108.

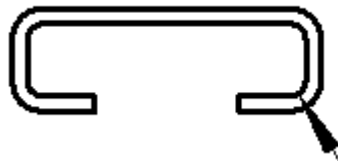
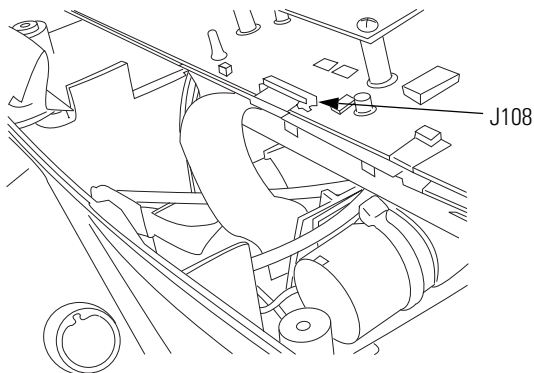

- Note** FOR MODELS NUMBERS (45MT0, 45ME0) ONLY: With diagonal cutting pliers cut jumper JP2 twice so that it is open. Cut it on each end on the dotted lines as illustrated, so that it is open connection.

## Key Pad Disassembly

1. Gently pull the button switch array out of the cover.
2. Align and push the new button switch array into place.

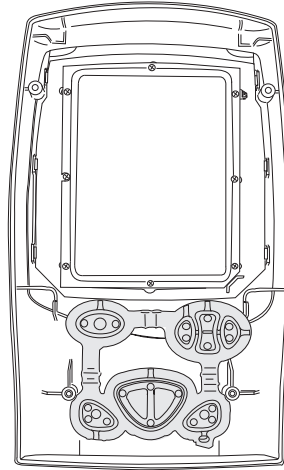

## SpO<sub>2</sub> Circuit Board Disassembly

**Note** To assure proper SpO<sub>2</sub> operation, replace the SpO<sub>2</sub> board using only the Welch Allyn specified part.

To assure patient electrical isolation, after the main board is nearly back in position, verify that the SpO<sub>2</sub> flex cable is freely floating in space and is not pressed up against the main board.

## Masimo

1. Lay the LCD flat on an ESD mat.
2. Find the double-stack of circuit boards and remove the four corners screws. Carefully lift the circuit board straight up.

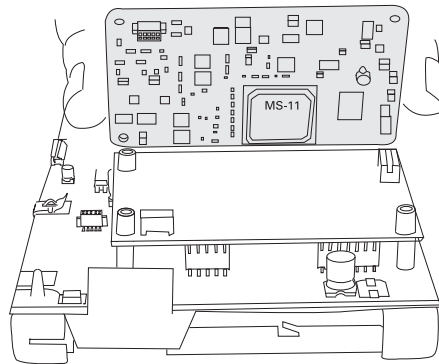
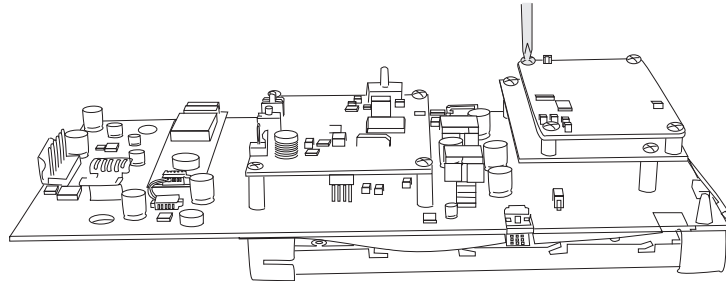

3. Remove the three screws on the circuit board located behind the LCD.

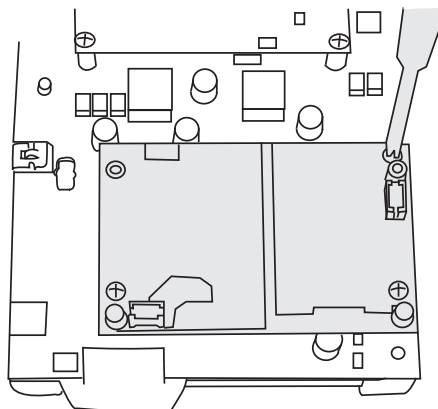

4. Slightly rock the circuit board back and forth while lifting straight up.

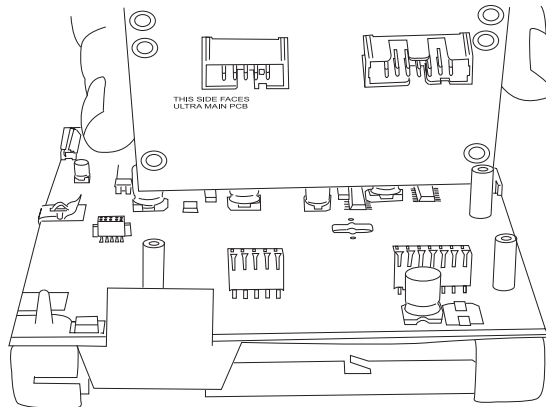

5. Replace with a new circuit board.

## Nellcor

1. Lay the LCD flat on an ESD mat.
2. Remove the three screws on the circuit board located behind the LCD.

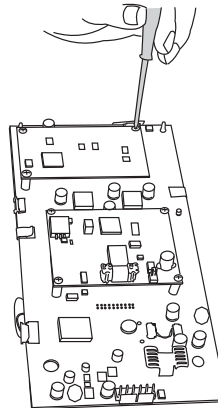

3. Slightly rock the circuit board back and forth while lifting straight up.

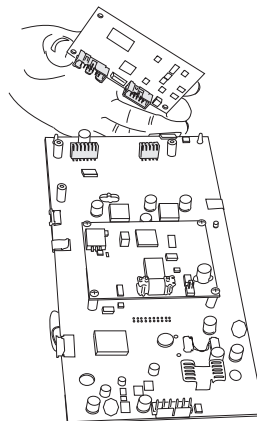

4. Replace with a new circuit board and set the dip switches to match the original board (dip 1 and 2: up / dip 3 and 4: down).

## Blood Pressure Circuit Board Disassembly

**Note** When replacing the NIBP board see "To initialize the NIBP board:" on page 54 for instructions.

Remove the four screws and carefully lift the circuit board straight up. There is one stationary connector.

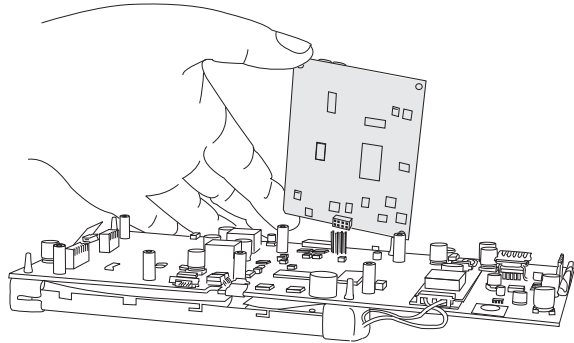
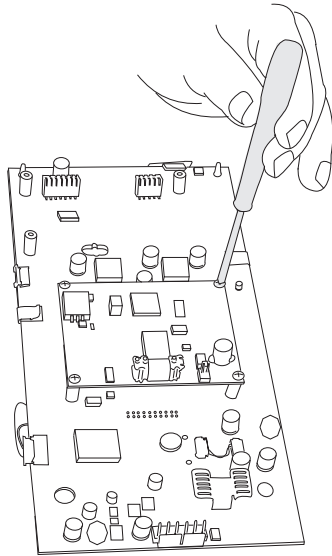

## LCD Inverter Ballast Board Disassembly

This is a small board held in place with two-sided tape. It is located towards the bottom of the main board. Remove the connector at each end and pull straight up while taking care not to damage the board because the adhesive tape has considerable sticking strength.

## LCD Disassembly

1. Remove the main board. At the bottom of this board is a circuit board with a pink connector at the bottom.

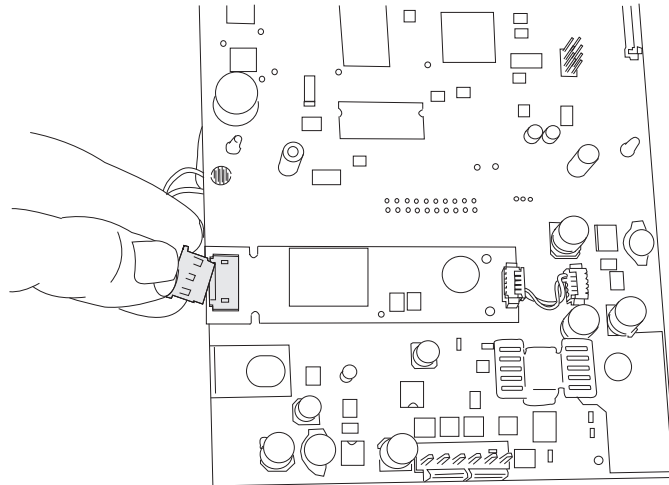

2. Pull the brown tabs of the top connector forward and remove the ribbon cable. Inspect connector tabs for wear and replace if worn.
3. Turn the board over and pull back the soft rubber holders. Pull the cable from the lug to remove the grounding strap and remove the LCD.

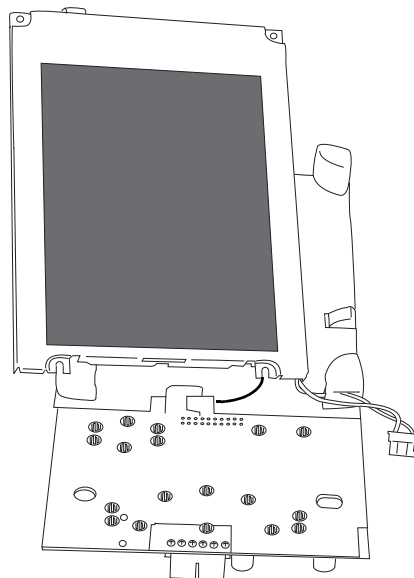

4. Replace with a new LCD.

## Pump Disassembly

**Note** For proper blood pressure operation, replace the pump using only the Welch Allyn specified part.

To assure patient electrical isolation, route the pump wires through the rear housing clip feature (near the pump terminals) and held in place with a tie-wrap to the holes in the rear housing at the back of the battery compartment.

To assure patient electrical isolation, do not modify the length of the pump wires.

1. Snip the wire ties (2 places).

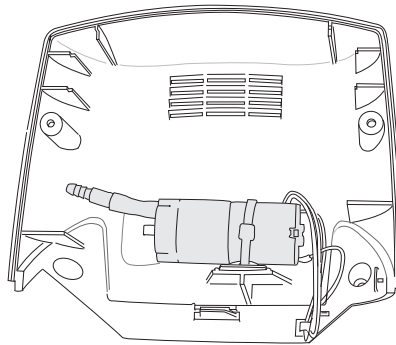

2. Disconnect the pneumatic tubing and unhook the wiring.
3. Replace with a new pump.

## RS232-Communication Circuit Board Disassembly

1. Remove the pneumatic connector and associated hoses from the pump and the two screws in the rear housing. Remove the associated hoses.
2. Release the catch and remove the cover and inner handle assembly.
3. Remove the connection port panel.
4. Remove the two screws inside the back housing and the ribbon cable that hold the RS232 board in place. Take care since the connector is easily broken.
5. Slide the board straight out and remove the wire harness.

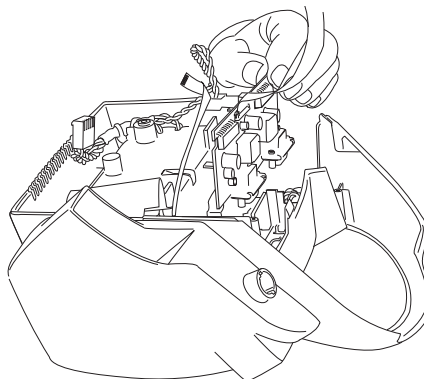

6. Replace with a new circuit board.



## Fan and Power Circuit Board Disassembly

**Note** To prevent buildup of hydrogen gas, replace the fan using only the Welch Allyn specified part.

This is a small board held in place with two-sided tape and one connector. Remove the screw before disconnecting the connector.

## Thermometry Circuit Board Disassembly



**Caution** To assure patient electrical isolation, trap the flex cable to the thermometer pod behind the clip on the main housing adjacent to the main board connection point.

**Caution** To assure patient electrical isolation, verify that the correct flex cable is used to connect the thermometer pod to the main board. The Braun and SureTemp Plus flex cables are slightly different in length and are not interchangeable.

**Caution** To protect the user from high voltage, properly install the thermometer pod insulating paper separating the LCD ballast wires from the housing crack.

## SureTemp Plus



**Caution** Do not attempt to repair or clean the solder joints on either SureTemp Plus board. Incorrect flux or technique can degrade thermometer accuracy.

1. Remove the two screws located at the thermometer housing with a T-10 torx wrench. Save the fish paper.

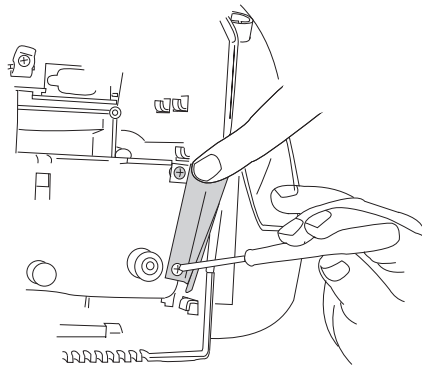

2. Locate the path of the notched tabs on the housing. Slide the housing up and out following this path and set the case aside.

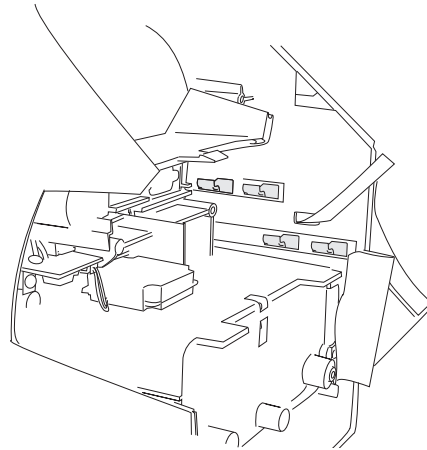

3. Remove the four screws from the mounting plate and save the fish paper. This exposes the circuit board.

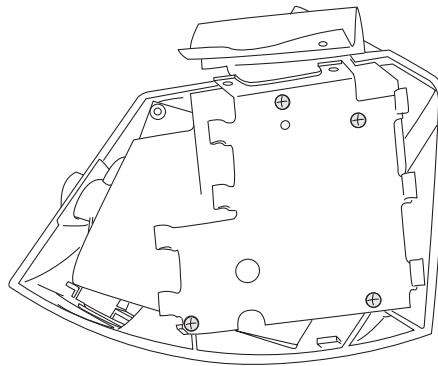

4. Remove the three Torx screws (T10) on the board (one on bottom and one on either side of the probe well cover) and lift the board out of the housing and orient the part as shown.

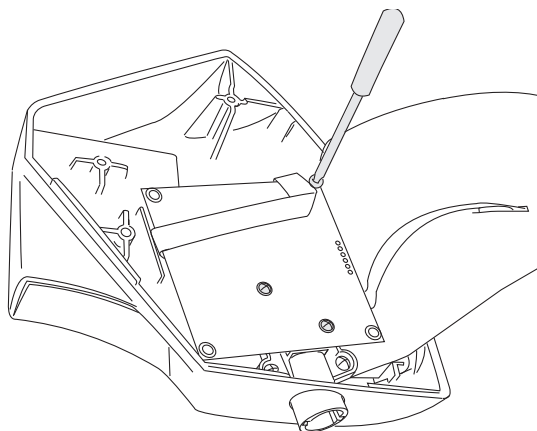

5. Disconnect all connectors and replace with a new board.

To replace the temperature connector, remove the one screw holding the temperature board and connector. Verify the fish paper is properly mounted upon reassembly.

When replacing the SpO2/blood pressure housing, verify the orange and white twisted wire is pushed as far into the **handle** housing as possible. Failure to do so can cause the wires to stretch when the SpO2/blood pressure housing is inserted.

## Braun ThermoScan PRO 4000

1. Remove the two screws located at the thermometer housing with a T-10 torx wrench. Save the fish paper.

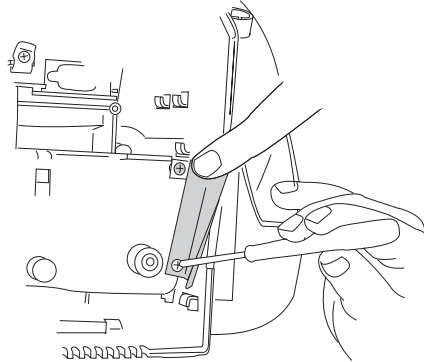

2. Locate the path of the notched tabs on the housing. Slide the housing up and out following this path and set the case aside.
3. Remove the four screws that hold the metal shield in place.

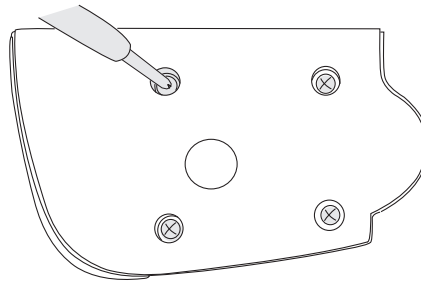

4. Remove the springs and posts. Carefully rock the board back and forth while lifting straight up.

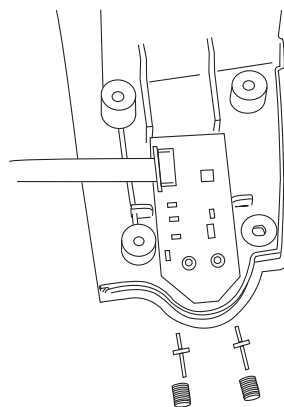

5. Disconnect all connectors and replace with a new board.
6. Reassembly is the reverse of disassembly.



# 12

## Repair Test Specifications

---

This appendix refers to the Spot Vital Signs LXi without pneumatics (tubing and cuff), temperature probe, SpO<sub>2</sub> probe, or main battery attached, unless otherwise noted.

Use the Repair Software for the performing the tests on the Spot Vital Signs LXi. The standard test voltage, unless otherwise stated is 6.5 Vdc (+0/-0.25 Vdc). Unless otherwise stated, all calibrated volumes are  $\pm 10$ cc of the stated volume.

### General Unit Test

#### A-D Noise Test

The A-D Noise Test is defined as the amount of noise on the Spot Vital Signs LXi A-D pressure channel; over a 1 second sample time while 0.0 mmHg is applied to the Device pressure port. The maximum limit is 0.050 mmHg.

#### Leak Test

The Leak Test is defined as the amount of pressure drop that is recorded over a 15-second interval with a 100cc cylinder attached to the Spot Vital Signs LXi pressure port and that volume having a stabilized pressure of 250 mmHg. The maximum limit is 6 mmHg.

#### Inflation Test

The Inflation Test is defined as the amount of time the Spot Vital Signs LXi pump can inflate a 250 cc cylinder from 5 mmHg to 210 mHg. The maximum limit is 7 seconds.

#### Dump Test

The Dump Test is defined as the amount of time it takes Spot Vital Signs LXi to deflate a 500 cc cylinder from 260 mmHg to less than 15 mmHg. The maximum limit is 10 seconds.

#### Pneumatic Accuracy Test

Enter the Internal Configuration Mode to perform this test (see "Temperature Functional Check" on page 58).

Perform an Auto-zero before starting this test (see "Temperature Functional Check" on page 58). The Pneumatic Accuracy test is defined as the comparison of Spot Vital Signs LXi's pressure measurement and applied pressure at 0, 50, 150, and 250 mmHg. The

specification for each reading is within  $\pm 3$  mmHg of the target pressure except for the 0 mmHg reading which is within  $\pm 1.0$  mmHg.

## Valve Control Test

Connect a 100 cc cylinder to the Spot Vital Signs LXi pressure port and pressurize to 160 mmHg. Give Spot Vital Signs LXi the commands to open the valve for 10 mmHg/s, 15 mmHg/s, and 25 mmHg/s. Record each pressure drop: 4 to 12 mmHg, 4 to 15 mmHg, and 4 to 25mmHg, respectively.

## Voltage Calibration

Calibrate the Spot Vital Signs LXi battery voltage measurement circuit at 5.5 Vdc (+0.1/-0.0 Vdc).

After performing a successful battery measurement circuit calibration, Spot Vital Signs LXi's memory will store a calibration signature of up to four printable characters.

## Blank Mode Current Test

The Blank Mode Current Test is defined as the amount of current drawn through the battery terminals. All LCD segments, the back light, and the SpO<sub>2</sub> mode are all turned off. The limit is 200 mA maximum.

## Back Light (Idle) Current Test

The Back Light Current Test is defined as the amount of current drawn through the battery. All LCD segments and the back light are turned on while the SpO<sub>2</sub> mode is turned off. The limit is 400 mA maximum.

## Valve/Pump Mode Current Test

The Valve/Pump Mode Current Test is defined as the amount of current that is drawn through the battery terminals; Spot Vital Signs LXi is in the Blank Mode while the valve and pump are actuated to on. The limit is 2.0 A maximum.

## Interface Test

When given the proper commands, the Display Window will turn on or off all segments and turn on or off the back light. When given the proper command, the buzzer sounds to verify operation. The user determines the pass/fail criteria.

# Temperature Option Requirements

## Accuracy Test

Verify the accuracy of the temperature module is within  $\pm 0.2^\circ$  F for readings with a normal temperature of  $97.3^\circ$  F ( $36.3^\circ$  C) using a Cal Key (5200-25). Verify Spot Vital Signs LXi can read a temperatures of  $96.4^\circ$  F ( $35.8^\circ$  C) and  $106^\circ$  F ( $41.1^\circ$  C) within  $\pm 0.3^\circ$  F/ $\pm 0.2^\circ$  C using a Welch Allyn 9600 Plus Calibrator.

## Temperature Probe Test

Spot Vital Signs LXi displays "ORL" after you remove the blue thermometer probe from the blue probe well.

## SpO<sub>2</sub> Option Requirements

These tests are only valid on Spot Vital Signs LXi models with the Masimo or Nellcor SpO<sub>2</sub> option.

## SpO<sub>2</sub> Functional Test

See "[Masimo SpO2 Functional Check](#)" or "[Nellcor SpO2 Functional Check](#)" on page 61 for the functional test.

## SpO<sub>2</sub> Mode Current Test

The SpO<sub>2</sub> Mode Current Test is defined as the amount of current, less the Blank Mode Current, that is drawn through the battery terminals, placing Spot Vital Signs LXi in the Blank Mode, actuating the SpO<sub>2</sub> mode and applying any SpO<sub>2</sub> signal to the device. The maximum limit is 120 mA maximum.

## Fail Safe Test

### Over Pressure Test

Verify that Spot Vital Signs LXi can detect over pressure on the pneumatic system between 296.0 mmHg and 329 mmHg.

### Over 15 mmHg

Verify that Spot Vital Signs LXi can detect static pressure over 15 mmHg for 180 seconds.







**WelchAllyn®**

Advancing Frontline Care™

Reorder No. 4500-89  
Material No.704432 Ver. D